

AUTOMETERS

SYSTEMS

I. Introduction

This document provides operating, maintenance and installation instructions of A-45 series. The unit measures and displays the characteristics of single phase two wires application. It provides voltage, current, power, frequency, power factor and energy information. A-45 series has both direct connect types and 5A CT operated types. The direct connect type can work with direct load 45A. Two Pulse outputs and 1 remote communication port is provided.

This series covers 6 models:

Model	Current Input	Communication
A-45M	Direct connect 45A	RS 485 Modbus
A-45MB	Direct connect 45A	M-Bus EN13757-3
A-45P	Direct connect 45A	---
A-45CTM	5A CT operated	RS 485 Modbus
A-45CTMB	5A CT operated	M-Bus EN13757-3
A-45CTP	5A CT operated	---

2. Specifications

2.1 General Specifications

Voltage AC (Un).....	230V
Voltage Range.....	176~276V AC
Current Input.....	0.25~5(45)A (SDM120 45A)
	0.25~5(6)A (SDM120 CT)
Power consumption.....	<2W/10VA
Frequency.....	50/60Hz (50Hz only for MID version)
AC voltage withstand.....	4KV for 1 minute
Impulse voltage withstand.....	6KV-1.2uS waveform
Overcurrent withstand.....	30I _{max} for 0.01s (SDM120 45A)
	20I _{max} for 0.01s (SDM120CT)
Pulse output rate.....	1000imp/kWh (default)
	100/10/1 imp/kWh/kVarh (configurable)
Display.....	LCD with white backlight
Max reading.....	99999.9kWh (SDM120 45A)
	999999 kWh (SDM120 CT)

2.2 Accuracy

Voltage.....	0.5% of range maximum
Current.....	0.5% of nominal
Frequency.....	0.2% of mid-frequency
Power factor.....	1% of Unity
Active power.....	1% of range maximum
Reactive power.....	1% of range maximum
Apparent power.....	1% of range maximum
Active energy.....	Class 1 IEC62053-21
	Class B EN50470-3 (MID product only)
Reactive energy.....	1% of range maximum

2.3 Environment

Operating temperature.....	-25°C to +55°C
Storage and transportation temperature.....	-40°C to +70°C
Reference temperature.....	23°C ±2°C
Relative humidity.....	0 to 95%, non-condensing
Altitude.....	up to 2000m
Warm up time.....	3s
Mechanical Environment.....	M1
Electromagnetic environment.....	E2
Degree of pollution.....	2

2.4 Mechanics

Din rail dimensions.....	18x119x62 (WxHxD) DIN 43880 DIN rail
Mounting.....	35mm
Sealing.....	IP51 (indoor)
Material.....	self-extinguishing UL94V-0

3. Display

3.1 Initialization Display

When it is powered on, the meter will initialize and do self-checking.

1	8888888	Full Screen. It will last for 3 seconds
2	020 105	Software version. It will last for 3 seconds
3	Ct 100	Ct1 (A-45CT* only) Primary current 5A-9999A Default: 5
4	000478	Total active energy (kWh)

After the self-checking program, the meter display will show the total active energy (kWh)

A-45 SERIES MID Approved B and D



- Measures kWh, Kvarh, KW, Kvar, KVA, PF, Hz, dmd, V, A, etc.
- Bi-directional measurement IMP & EXP
- Two pulse outputs
- RS485 Modbus
- Din Rail one Module width (18mm)
- 45A direct connected
- 5 Amp C.T operated
- Better than Class 1 accuracy

3.2 Scroll Display Button

After the self-checking program, the meter display will show the total active energy (kWh)

	Click the button, the LCD display will scroll the measurements.
	Keep pressing the button for 3 seconds, the meter will get into set-up mode.

1	000478	Total active energy(kWh) Display format: 0000.00 → 9999.99 → 10000.0 → 99999.9 → 0000.00
1-1	000245	Import active energy(kWh) Display format: 0000.00 → 9999.99 → 10000.0 → 99999.9 → 0000.00
1-2	000232	Export active energy(kWh) Display format: 0000.00 → 9999.99 → 10000.0 → 99999.9 → 0000.00
2	2198	Voltage (V)
3	20.18	Current (A)
4	22102	Active power (W)
5	F 5000	Frequency (F)
6	PF 100	Power factor (PF)
7	Ct 100	CT 1(A-45CT* only) Primary current 1A-9999A Default: 5
8	Ct 5	CT 2(A-45CT* only) Secondary current 1A or 5A Default: 5
9	Addr001	Vodbus Address or Primary address Default: 00
10	b 2400	Baudrate Default: 2400bps
11	None	Parity None/Even/Odd are optional Default: none
12	H 0000	V-Bus secondary address High (M-Bus version only)
13	L 0000	V-Bus secondary address Low (M-Bus version only)
14	020 105	Software version In kind prevail

3.3 The Display of Each Model

A-45M:

Total kWh → Import kWh → Export kWh → Voltage → Current → Active power → Frequency → Power factor → Power factor → Address → Baudrate → Parity → Software version

A-45MB:

Total kWh → Import kWh → Export kWh → Voltage → Current → Active power → Frequency → Power factor → Power factor → Address → Baudrate → Parity → Secondary → Address High → Secondary Address Low → Software version

4. Communication

4.1 Pulse Output

The meter is equipped with 2 pulse outputs, which are fully isolated from the inside circuit. That generates pulses in proportion to the measured energy. The pulse outputs are polarity dependent, passive transistor output requiring an external voltage source for correct operation. For this external voltage source, the voltage shall be 5-27V DC, and the maximum input current shall be 27mA DC.

ATTENTION: Pulse output must be fed as shown in the adjacent wiring diagram. Ensure polarities and connection mode are correct. Opto-coupler with potential-free SPST-No Contact.

Contact range: 5-27V DC
Max current input: 27mA DC

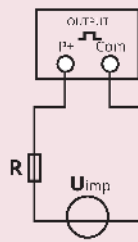

4.2 Pulse Output 1 (A-45M/A-45MB/A-45CTM/A-45CTMB only)

Pulse output 1 is configurable. The pulse output 1 can be set to generate pulses to represent total/import/export/kWh or kWh. The pulse constant can be set to generate 1 pulse per: 0.0001 (default) / 0.001 / 0.1 / 1 kWh / kWh. Pulse width: 200 / 100 / 60ms (default)

4.3 Pulse Output 1 (A-45P and A-45CTP only)

Pulse output 1 is non-configurable. It is fixed up with Export kWh. The constant is 1000imp/kWh.

4.4 Pulse Output 2

Pulse output 2 is non-configurable. It is set as import kWh. The pulse width: 60ms.

4.5 RS485 output for Modbus RTU (A-45CTMB only)

The meter provides a RS485 port for remote communication. Modbus RTU is the protocol applied. For Modbus RTU, the following RS485 communication parameters can be configured from the set-up menu.

Baud rate: 1200, 2400, 4800, 9600
Parity: NONE / EVEN / ODD
Stopbits: 1 or 2
Modbus address: 1 to 247

4.6 M-Bus communication EN13757-3 (A-45CTM and A-45CTMB only)

The meter provides an M-Bus port for remote communication. The protocol fully complies with EN13757-3. The following communication parameters can be configured via M-Bus communication.

Baud rate: 300, 600, 2400, 4800, 9600
Parity: NONE / EVEN / ODD
Stopbits: 1 or 2
M-Bus network primary address: m - 3 digits number from 001 to 250
M-Bus secondary address: 00 00 00 00 to 99 99 99 99

Please contact us for the detailed Modbus/M-Bus communication protocol. info@autometers.co.uk

5. Dimensions

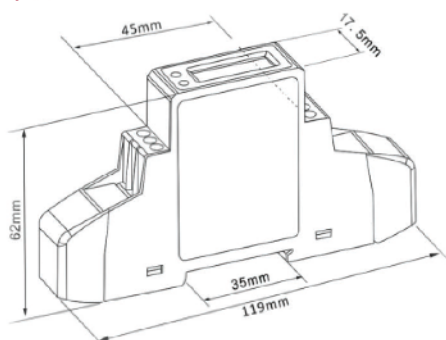

6. Safety

6.1 Safety Instructions

This manual does not contain all the safety instructions for the operation of the equipment (module, device) because special operating conditions and local code requirements or regulations may necessitate further measures. However, it does contain information which must be read for your personal safety and to avoid material damages. This information is highlighted by a warning triangle and is represented as follows, depending on the degree of potential danger.



WARNING

This means that failure to observe the instruction can result in death, serious injury, or considerable material damage.



CAUTION

This means hazard of electric shock and failure to take the necessary precautions will result in death, serious injury or considerable material damage.

Qualified Personnel

Operation of the equipment (module, device) described in this manual may only be performed by qualified personnel. Qualified personnel, in this manual, means persons who are authorised to commission, start up, ground and label devices, systems and circuits according to safety and regulatory standards.

Proper Handling

The prerequisites for perfect, reliable operation of the product are proper transport, storage installation, and assembly as well as proper operation and maintenance. When operating electrical equipment, certain parts of this equipment automatically carry dangerous voltages. Improper handling can therefore result in serious injuries or material damage.

- Use only insulating tools
- Do not connect while circuit is live (hot)
- Place the meter only in dry surroundings
- Do not mount the meter in an explosive area or expose the meter to dust, mildew and insects
- Make sure the used wires are suitable for the maximum current of this meter
- Make sure the AC wires are connected correctly before activating the current/voltage to the meter
- Do not connect the meter to a 3 phase - 400VAC - network
- Do not touch the meter connecting clamps directly with your bare hands, with metal, blank wire or other material as you may get an electrical shock
- Make sure the protection cover is placed after installation
- Installation, maintenance and reparation should only be done by qualified personnel
- Never break the seals and open the front cover as this might influence the functionality of the meter and will void the warranty
- Do not drop or allow physical impact to the meter as there are high precision components inside that may break

7. Installation

The A45 series is designed to fit a standard 35mm DIN Rail

8. Wiring diagrams

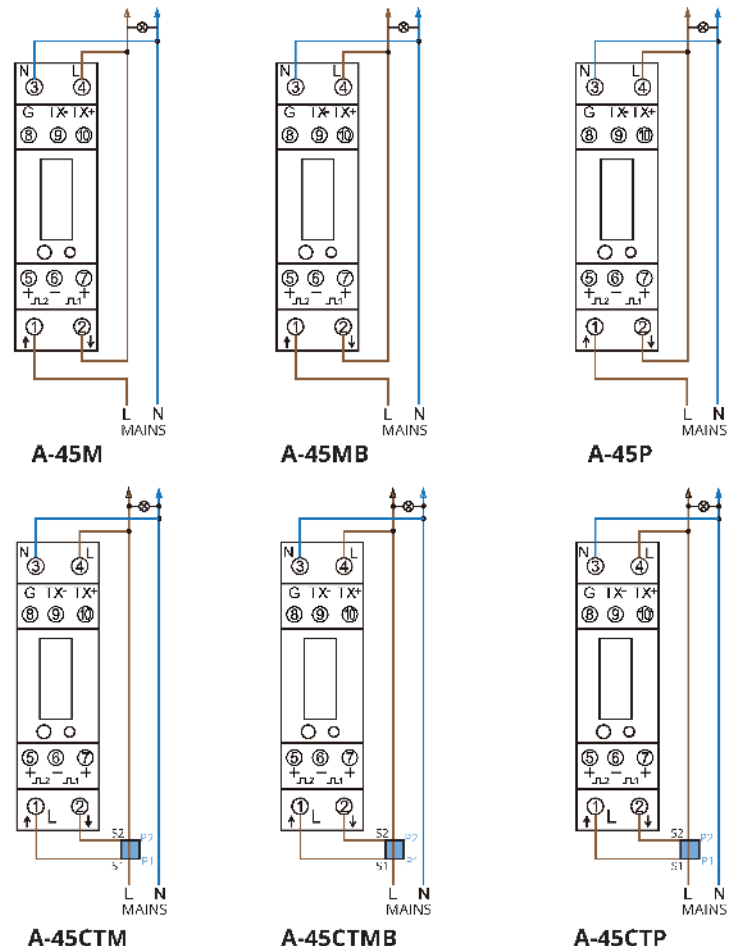

Product development is continuous and Autometers Systems Limited reserves the right to make alterations and manufacture without notice. Products as delivered may therefore differ from the descriptions and illustrations in this publication

Ref. A-45.01.2019

Autometers Systems Ltd.
4B Albany Road, Chorlton-cum-Hardy
Manchester M21 0AW
Email: sales@autometers.co.uk
Phone: 00(44) 0161 861 9056
Fax: 0161 881 3745
www.autometers.co.uk



AUTOMETERS
SYSTEMS