

# Digitale 3-Phasen Power Meter

IIST036-01 Stand 07-09-2010

Direktanschluß bis 80 A - Wandlerstromanschluß für .../5 A bis 10.000/5 A

## Bedienungsanleitung

Die Power Meter dienen zur Messung wichtiger Parameter wie I, U, PF, F sowie aller Leistungen je Phase auf einem Blick; Übersicht der gelieferten, bzw. abgegebener Energie.

Kode	Beschreibung
ADP3-80C	Digitaler 3-Phasen Power Meter für Direktanschluß 0.25-5 (80) A - 1 Tarif - 2 SO (für seitliche IR Kommunikation eingerichtet)
ADP3-5C	Digitaler 3-Phasen Power Meter für Wandlerstromanschluß ... /5 A bis 10.000/5 A - 0.05-5 (6) A - 1 Tarif - 2 SO (für seitliche IR Kommunikation eingerichtet)



# Three-phase Digital Power Meter

Direct connection 80 A - Connection through CT .../5 A till 10.000/5 A

## Operating instructions

The Power Meter offers important measurements parameter like I, U, PF, F and all power parameters monitoring all three phases in one time, export and import energy register are available.

Code	Description
ADP3-80C	three-phase digital power meter for direct connection 0.25-5 (80) A - 1 tarif - 2 SO (set up for side IR communication)
ADP3-5C	three phase digital power meter with connection by CT .../5 A, up to 10.000/5 A - 0.05-5 (6) A - 1 tarif - 2 SO (set up for side IR communication)



### ⚠ WARNING

Die Installation muß von einer Elektrofachkraft oder unter deren Leitung und Aufsicht durchgeführt und geprüft werden. Bei Arbeiten am Meßgerät, Netzspannung abschalten!

### ⚠ WARNING

Installation must be carried out and inspected by a specialist or under his supervision. When working on the instrument, switch off the mains voltage!

## Einstellung der Meßwerte / Measurements Valori misurati / Valeurs mesurées - Start Up

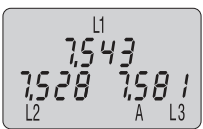

Phasenströme - Rückbeleuchtung aus  
Line currents Backlight OFF  
Correnti di Fase - Display spento  
Courants de Phase - Display éteint

Jede Taste drücken  
Any Key pushing  
Qualunque tasto  
Quelconque touche

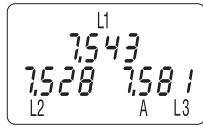

Phasenströme - Rückbeleuchtung ein  
Line currents Backlight ON  
Correnti di Fase - Display acceso  
Courants de Phase - Display allumé

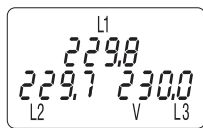

V-L/N

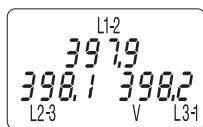

V-L/L

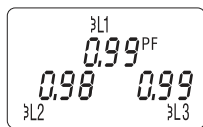

PF-L

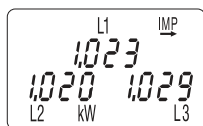

W-L



Q-L

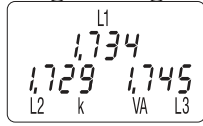

S-L

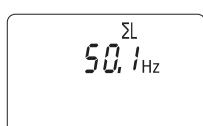

Σ F (Hz)

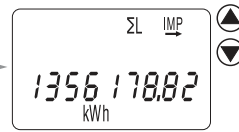

Σ Wh import

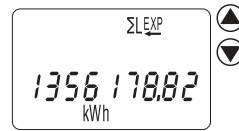

Σ Wh export

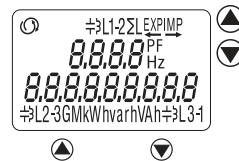

## Einstellung der Parameter (password unfähig) Parameter-Password disabled (OFF) Parametri-Password disabilitata (OFF) / Réglage des paramètres (OFF) - Start Up

Taste als 2 Sek. drücken um Parameter zu ändern  
To change the parameter push for more than 2 sec.  
Per modificare i parametri premere per più di 2 sec.  
Pour charger le paramètre presser pour plus de 2 sec.

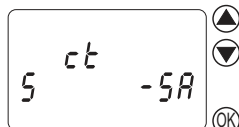

Seitenwahl  
Page selection  
Selezione di pagina  
Sélection de page

Bestätigen / Confirm / Conferma / Confirmez

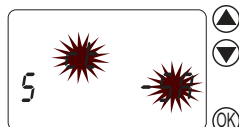

+  
-

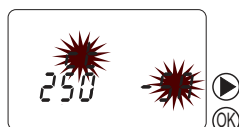

Löschen / Cancel / Annulla / Annulation  
Bestätigen / Confirm / Conferma / Confirmez

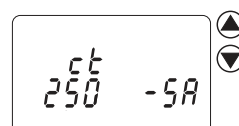

Seitenwahl  
Page selection  
Selezione di pagina  
Sélection de page

# Power Meter Digitale Trifase

Connessione diretta 80 A - Connessione a mezzo TA .../5 A fino 10.000 A

## Istruzioni di servizio

Lo strumento Power Meter serve per la misura di parametri importanti come I, U, PF, F e potenze per ogni fase in unica visione; lettura dell'energia attiva fornita e consumata.

Codice	Descrizione
ADP3-80C	power meter digitale trifase connessione diretta 0.25-5 (80) A - 1 tariffa - 2 SO (laterare IR predisposto per la comunicazione)
ADP3-5C	power meter digitale trifase connessione a mezzo TA .../5 A fino a 10.000/5 A - 0.05-5 (6) A - 1 tariffa - 2 SO (laterare IR predisposto per la comunicazione)



### ⚠ ATTENZIONE

L'installazione deve essere effettuata e verificata da uno specialista o sotto la sua supervisione.  
Togliere tensione prima di intervenire sull'apparecchio.

# Power Meter Digital Triphasé

Connexion directe 80 A - Connexion à TC .../5 A jusqu'à 10.000 A

## Mode d'emploi

L'indicateur Power Meter propose des mesures de paramètres importants comme I, U, PF, F et tous les paramètres du pouvoir de contrôle des trois phases en une seule fois, l'exportation et l'importation enregistrent aucune énergie sont disponibles.

Code	Description
ADP3-80C	power meter triphasé pour connexion directe 0.25-5 (80) A 1 tarifs - 2 SO (établi pour la communication IR latérale)
ADP3-5C	power meter triphasé pour connexion à l'aide de TC .../5 A jusqu'à 10.000/5 A - 0.05-5 (6) A - 1 tarifs - 2 SO (établi pour la communication IR latérale)



### ⚠ ATTENTION

L'installation doit être effectuée et contrôlée par un spécialiste ou bien sous sa supervision.  
Débrancher les différents branchements au secteur avant d'intervenir sur l'appareil!

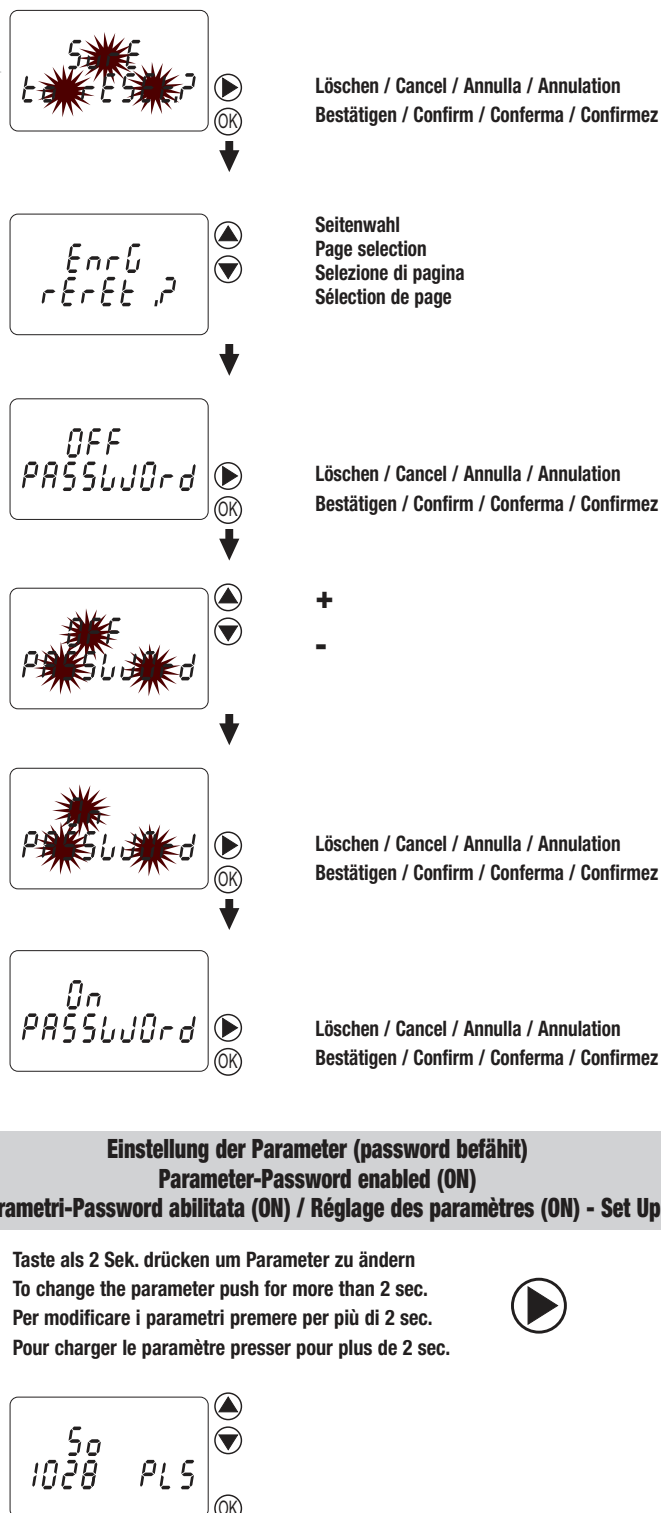
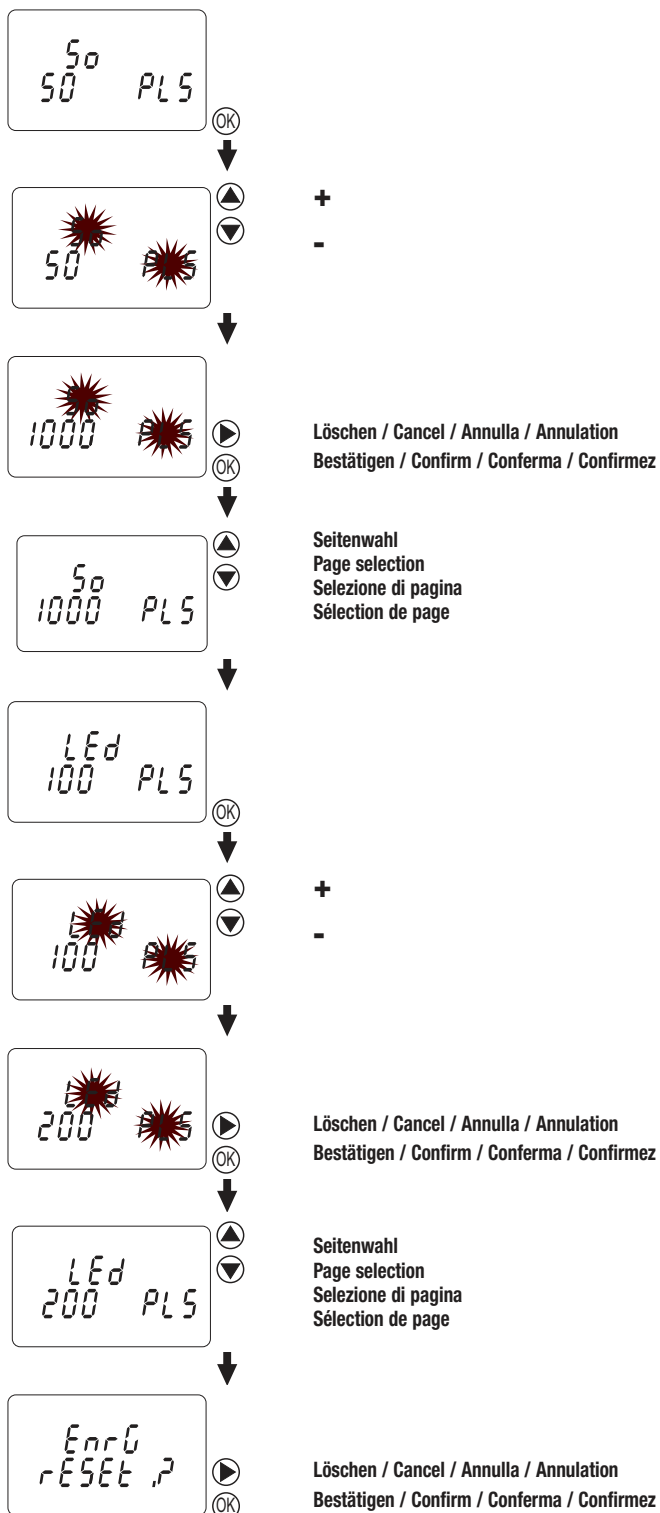

### Einstellung der Parameter (password befähigt) Parameter-Password enabled (ON) Parametri-Passwort abilitata (ON) / Réglage des paramètres (ON) - Set Up

Taste als 2 Sek. drücken um Parameter zu ändern  
To change the parameter push for more than 2 sec.  
Per modificare i parametri premere per più di 2 sec.  
Pour charger le paramètre presser pour plus de 2 sec.

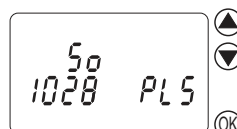

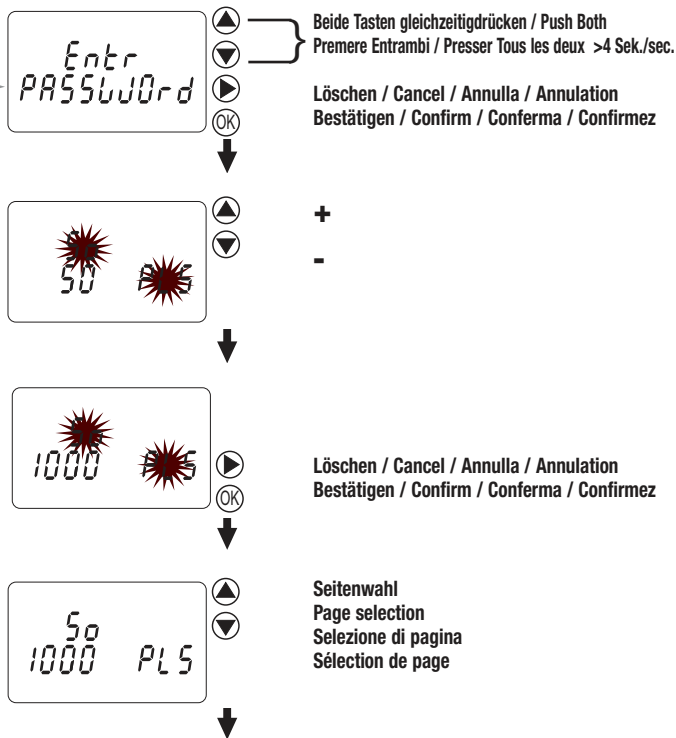

Nach 60 Sek. Tasten inaktivität muß die Password erneut eingegeben werden  
After 60 sec. of inactivity reenter the password  
Dopo 60 sec. di inattività reinserire la password  
Après 60 sec. d'inactivité réinsérer le password

### Anzeige bei Phasenausfall und falschen Phasensequenzanschluß Phases Sequence Error Message / Messaggio Inversione di Fase Message d'Erreur de Séquence des Phases

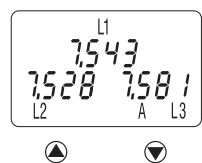
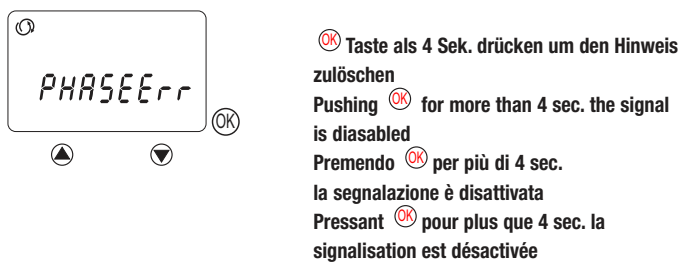

### Kabel-Abisolierlänge und Max Drehmoment Cable stripping length and max terminal screw torque Lunghezza di spelatura dei fili e coppia massima di serraggio Longueur de dénudage des fils et couple de serrage maximum

80 A Direktanschluss Hauptklemmen - Schraubendreher PZ2  
80 A direct connection main terminals - Screw driver PZ2  
80 A connessione diretta morsetti principali - Cacciavite PZ2  
80 A connexion directe bornes principales - Tournevis PZ2

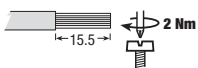

5 A Wandleranschluss Hauptklemmen - Schraubendreher PZ1  
5 A CT connection main terminals - Screw driver PZ1  
5 A connessione TA morsetti principali - Cacciavite PZ1  
5 A connexion TA bornes principales - Tournevis PZ1

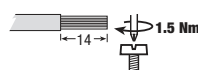

Tarif- und Datenübertragungsklemmen - Schraubendreher Klinge 0.8x3.5 mm  
Tariff and communication terminals - Screw driver blade 0.8x3.5 mm  
Morsetti tariffe e comunicazioni - Cacciavite a taglio 0.8x3.5 mm  
Bornes tarifs et communications - Tournevis a corta 0.8x3.5 mm

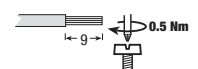

### Power Meter für Wandleranschluß Power Meter with connection with CT Power Meter con connessione a mezzo TA Power Meter pour connexion à l'aide de TC

50 Impulse für kWh / 50 Pulses for kWh / 50 Impulsi per kWh / 50 impulsion en kWh  
(immer auf 16,6 Hz begrenzt) / (always limited to 16.6 Hz) / (sempre limitata a 16,6 Hz) / (toujours limitées à 16,6 Hz)

Für 80 A-Modell wird der verfügbare Bereich 1 ... 500 Imp./kWh  
Für xx/5A, hängt die verfügbare Bandbreite ab, laut externen CT, wie folgt:

For 80 A model, the available range is 1 ... 500 pulses/kWh  
For xx/5A, the available range depends on external CT, as follows:

Per il modello 80 A, la gamma disponibile è di 1 ... 500 impulsi/kWh  
Per il modello xx/5A, la gamma disponibile dipende dal TA esterno, come segue:

Pour le modèle 80 A, la gamme disponible est de 1 ... 500 impulsions / kWh  
Pour le modèle xx/5A, la gamme disponible dépend du TC externes, comme suit:

CT - TA - TC	Bereich / Range / Portata / Portée
5	1 ... 10000
10	1 ... 5000
15 ... 30	1 ... 2000
35 ... 60	1 ... 1000
65 ... 120	1 ... 500
125 ... 300	1 ... 200
305 ... 600	1 ... 100
605 ... 1200	1 ... 50
1205 ... 3000	1 ... 20
3005 ... 6000	1 ... 10
6005 ... 10000	1 ... 5

LED Impulse für kWh / LED Pulses for kWh / Impulsi LED per kWh / LED impulsion en kWh  
(immer auf 50 Hz begrenzt) / (always limited to 50 Hz) / (sempre limitata a 50 Hz) / (toujours limitées à 50 Hz)

Für 80 A-Modell wird der verfügbare Bereich 1 ... 2000 Imp./kWh  
Für xx/5A, hängt die verfügbare Bandbreite ab, laut externen CT, wie folgt:

For 80 A model, the available range is 1 ... 2000 pulses/kWh  
For xx/5A, the available range depends on external CT, as follows:

Per il modello 80 A, la gamma disponibile è di 1 ... 2000 impulsi/kWh  
Per il modello xx/5A, la gamma disponibile dipende dal TA esterno, come segue:

Pour le modèle 80 A, la gamme disponible est de 1 ... 2000 impulsions / kWh  
Pour le modèle xx/5A, la gamme disponible dépend du TC externes, comme suit:

CT - TA - TC	Bereich / Range / Portata / Portée
5 ... 15	1 ... 10000
20 ... 35	1 ... 5000
40 ... 90	1 ... 2000
95 ... 180	1 ... 1000
185 ... 360	1 ... 500
365 ... 900	1 ... 200
905 ... 1800	1 ... 100
1805 ... 3600	1 ... 50
3605 ... 9000	1 ... 20
9005 ... 10000	1 ... 10

### Maße / Dimension Dimensioni / Dimensions

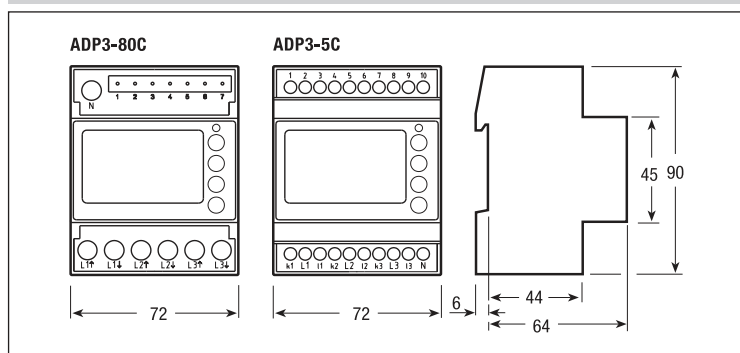

**Schaltbild / Wiring diagram  
Schema di cablaggio / Schéma de câblage**

**direkt - direct - direct - direc. 80 A**

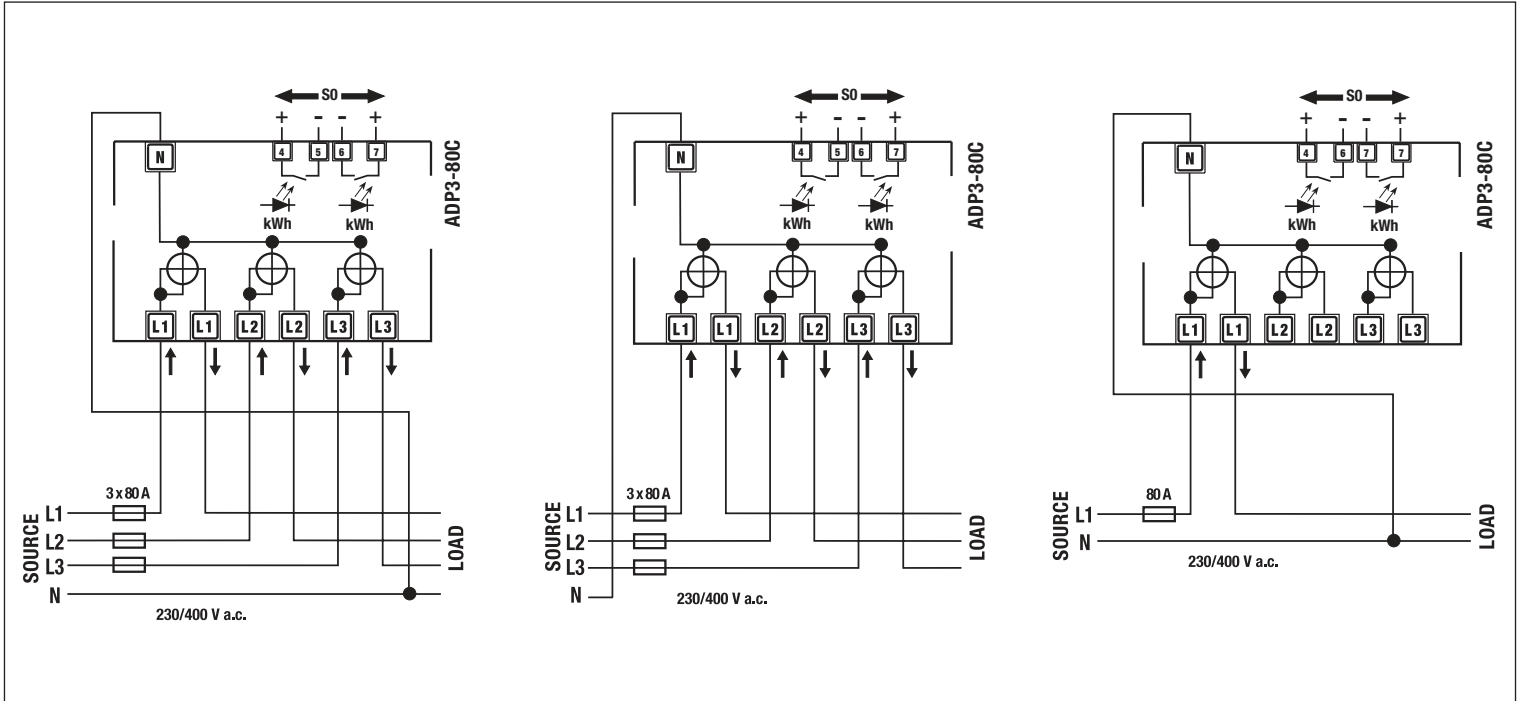

“Der N-Leiter muß am Power-meter angeschlossen werden”

“Wire N needs to be connected to the Power-meter”

“Il Neutro deve essere collegato al Power-meter”

“Le conducteur N doit être branché au Power-meter”

**Wandler - CT - TA - TC .../5 A**

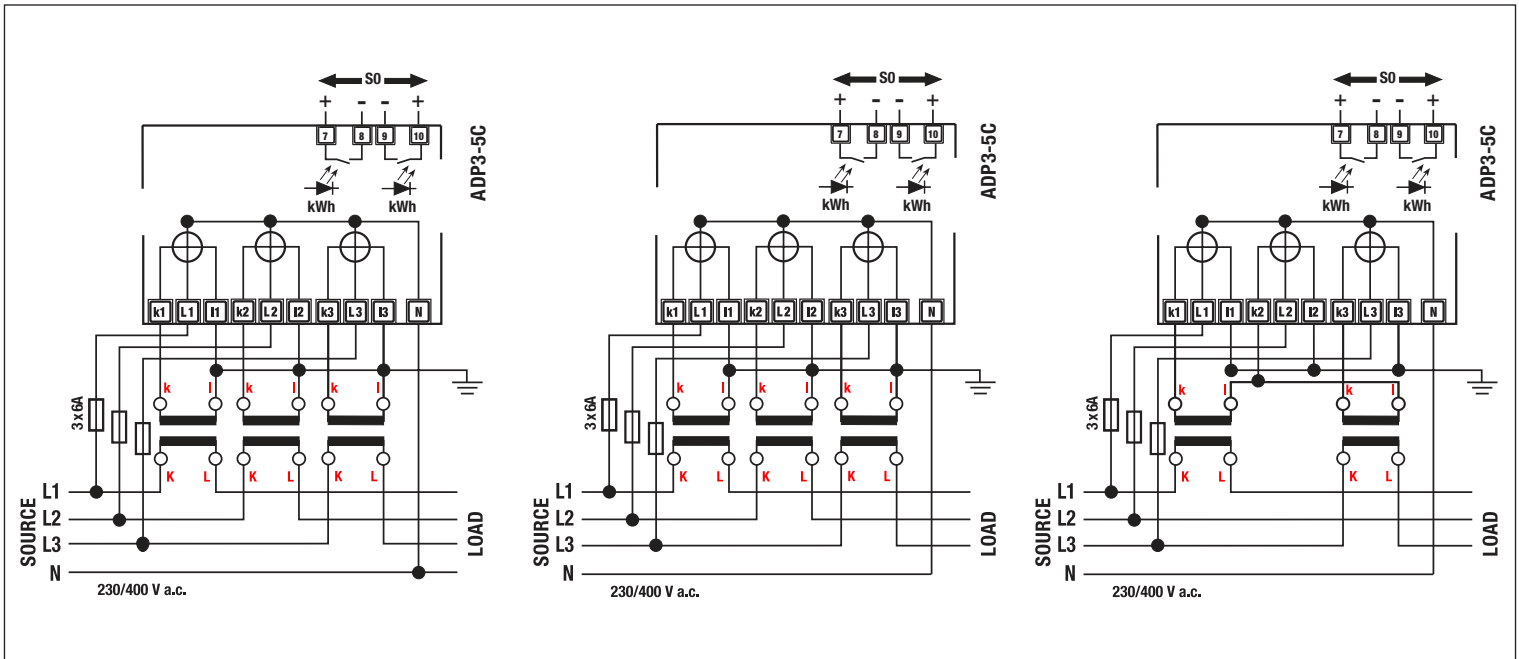

“Der N-Leiter muß am Power-meter angeschlossen werden”

“Wire N needs to be connected to the Power-meter”

“Il Neutro deve essere collegato al Power-meter”

“Le conducteur N doit être branché au Power-meter”

**Hinweis für den Anschluss von Wandlerzählern**

Für den Leitungsschutz werden Absicherungen von 6 A empfohlen. Stromwandler dürfen nicht mit offenen Klemmen betrieben werden, da gefährlich hohe Spannungen auftreten können. Nichtbeachtung kann zu Personen- und Sachschäden führen. Außerdem können die Wandler thermisch überlastet werden.

**Instructions for the connection of transformer counters**

A fuse of 6 A is recommended for the line protection. Current transformers must not be operated with open terminals since dangerous high voltages might occur which may result in personal injuries and property damage. In addition to this, the transformers are exposed to thermal overload.

**Istruzioni per il collegamento dei TA**

Per la protezione della linea si consiglia un fusibile da 6 A. I trasformatori di corrente non devono funzionare con i terminali/morsetti aperti, perché possono aversi delle tensioni pericolosamente elevate, che possono provocare lesioni alle persone e danni alle cose. I trasformatori sono inoltre esposti al sovraccarico termico.

**Instructions pour le branchement des TC**

Pour la protection de la ligne, il est recommandé un fusible de 6 A. Les transformateurs de courant ne doivent pas fonctionner avec les bornes/plots ouverts en raison des tensions dangereusement élevées qui pourraient rovoquer des lésions aux personnes ou des dommages aux choses. Les transformateurs peuvent par ailleurs être exposés à une surcharge thermique.

---

---

---

---

---

---

---

---

A large grid of graph paper for writing notes, consisting of 25 columns and 35 rows of small squares.

A large grid of graph paper for writing notes, consisting of 25 columns and 35 rows of small squares.

Conforme aux normes EN 50470-1, EN 50470-3, EN 62053-23, EN 62053-31

**Caractéristiques générales**

• Boîtier	DIN 43880
• Fixation	EN 60715
• Profondeur	

**Fonctionnement**

• Connexion	à une charge en monophasé en triphasé (n° fils)
• Mémorisation de la configuration/données	mémoire flash interne
• Indication tarif actuel	pour énergie il active et réactive

**Alimentation**

• Tension nominale d'alimentation $U_n$	
• Domaine de variation	
• Fréquence nominale $f_n$	
• Puissance absorbée (max. de phase) $P_v$	

**Surchargeabilité**

• Tension $U_n$	permanent: phase/phase 1 sec.: phase/phase permanent: phase/N 1 sec.: phase/N
• Courant $I_{max}$	permanent momentané (0,5 s) momentané (10 ms)

**Visualisation (lecture)**

• Erreur de branchement et manque phase	identifiable par l'indic. séquence phases
• Afficheur	LED - Énergie LED - Grandeur instantanées dimension digit
• Énergie active: 1 indicateur, 8 chiffres + indication absorbée ou distribuée (flèche)	1 tarif flux le plus grand
• Puissance active instantanée: 1 indic., 3 chiffres	
• Puissance réactive instantanée: 1 indic., 3 chiffres	
• Puissance apparente instantanée: 1 indic., 3 chiffres	
• Tarif actuel	1 indicateur, 1 chiffre
• Primaire du transform. de courant	settaggio est impostabile à des pas de 5 A
• Cycle de visualisation	

**Précision**

• Énergie et puissance actives	conforme EN 50470-3
• Énergie et puissance réactive	conforme EN 62053-23

**Entrées de mesure**

• Insertion	
• Tension $U_n$	phase/phase phase/N
• Domaine de tension	phase/phase phase/N
• Courant $I_{ref}$	
• Courant $I_n$	
• Courant $I_{min}$	
• Domaine de courant ( $I_{st} \dots I_{max}$ )	connexion directe connexion TC .../5 A
• Transformateur de courant	primaire minimum imp.
• Fréquence	
• Forme d'onde en entrée	sinusoïdal
• Courant initial pour la mesure d'énergie ( $I_{st}$ )	

**Interface S0**

• Sortie impulsion	conforme EN 62053-31 1 sortie impulsion d'énergie à l'exportation 1 sortie d'impulsion des importations d'énergie connexion directe 80 A
• Quantité impulsion	con. TC .../5 A, sélection. automat. (vois tableau)
• Durée impulsion	
• Tension nécessaire	min ... max
• Courant permis	impulsion ON (max 230 V a.c./d.c.)
• Courant permis	imp. OFF (cour. de disper. max 230 V a.c./d.c.)

**Sortie impulsion**

• Calibrage frontal ( <b>contrôle de précision</b> )	LED
--	-----

**Interface IR latérales**

• Pour le raccordement de moduls de communication (LAN-TCP/IP / M-Bus / Modbus RTU / RS-485 / KNX-EIB / SD-Card Datalogger)	
--	--

**Sécurité selon les normes EN 50470-1**

• Installation pour intérieurs	
• Degré de pollution	
• Tension d'exercice	
• Classe de protection (EN 50470)	
• Épreuve tension d'impulsion	
• Tension d'essai AC (EN 50470-3, 7.2)	
• Résistance du boîtier à la flamme	UL 94

**Bornes de connecter**

• Type cage borne courant principale	tête de la vis Z +/-
• Type cage borne sortie impulsion	tête de la vis à fente
• Type cage borne tension principale	fil compact min. (max) fil flexible avec cosse min. (max)
• Type cage borne sortie impulsion	fil compact min. (max) fil flexible avec cosse min. (max)

**Conditions ambiantes**

• Environnement mécanique	
• Environnement électromagnétique	
• Température d'utilisation	
• Limite de la température d'emmagasinage et de transport	
• Humidité relative (non condensé)	
• Vibrations	amplitude vibration sinusoïdale à 50 Hz
• Indice de protection	appareil installé frontalement (bornes)

(⇒) Pour l'installation dans un coffret au moins avec la protection IP51

## Dati tecnici

ITALIANO

Secondo Norma EN 50470-1, EN 50470-3, EN 62053-23, EN 62053-31

### Caratteristiche generali

• Custodia	DIN 43880
• Fissaggio	EN 60715
• Profondità	

### Funzionamento

• Connessione	a un carico monofase / trifase (n° fili)
• Memorizzazione energia misurata e config.	memoria flash interna
• Indicazione tariffa attuale	per energia attiva e reattiva

### Alimentazione

• Tensione nominale di alimentazione <b>Un</b>	
• Campo di variazione tensione	
• Frequenza nominale <b>fn</b>	
• Potenza assorbita (max. per fase) <b>Pv</b>	

### Sovraccaricabilità

• Tensione <b>Un</b>	permanente; fase/fase 1 secondo: fase/fase permanente; fase/N 1 secondo: fase/N
• Corrente <b>I<sub>max</sub></b>	permanente momentanea (0,5 s) momentanea (10 ms)

### Visualizzazione (lettura)

• Errore di collegamento e mancanza fase	riconoscibile dall'indicazione sequenza fasi
• Display	LCD - Energia LCD - Grandezze istantanee dimensione digit
• Energia attiva: 1 indicatore, 8 cifre + indicazione assorbita o erogata (freccia)	1 tariffa flusso massimo
• Potenza attiva istantanea: 1 indicatore, 3 cifre	
• Potenza reattiva istantanea: 1 indicatore, 3 cifre	
• Potenza apparente istantanea: 1 indicatore, 3 cifre	
• Tariffa attuale	1 indicatore, 1 cifra
• Trasformatore di corrente primaria	il settaggio è impostabile a passi da 5 A
• Ciclo di visualizzazione	

### Precisione

• Energia e potenza attiva	secondo EN 50470-3
• Energia e potenza reattiva	secondo EN 62053-23

### Ingressi di misura

• Inserzione	
• Tensione <b>Un</b>	fase/fase fase/N fase/fase fase/N
• Campo di tensione	
• Corrente <b>I<sub>ref</sub></b>	
• Corrente <b>In</b>	
• Corrente <b>I<sub>min</sub></b>	
• Campo di corrente ( <b>I<sub>st</sub> ... I<sub>max</sub></b> )	connessione diretta inserzione TA .../5 A
• Trasformatore di corrente	primaria minimo impostabile
• Frequenza	
• Forma d'onda in ingresso	sinusoidale
• Corrente iniziale per la misura di energia ( <b>I<sub>st</sub></b> )	

### Interfaccia S0

• 2 uscite impulso	secondo EN 62053-31 1 uscita impulso energia - export 1 uscita impulso energia - import connessione diretta 80 A connes. TA .../5 A, impost. automat. (vedi tabella)
• Quantità impulso	
• Durata impulso	
• Tensione necessaria	min ... max
• Corrente consentita	impulso ON (max 230 V a.c./d.c.)
• Corrente consentita	impulso OFF (cor. di disper. max 230 V a.c./d.c.)

### Interfaccia ottica

• Calibratura frontale ( <b>controllo di precisione</b> )	LED
---	-----

### Interfaccia laterale IR

• Per il collegamento ai moduli di comunicazione (LAN-TCP/IP / M-Bus / Modbus RTU / RS-485 / KNX-EIB / SD-Card Datalogger)	
--	--

### Sicurezza secondo EN 50470-1

• Installazione per interni	
• Classe inquinamento	
• Tensione di funzionamento	
• Classe di protezione (EN 50470)	
• Prova tensione di impulso	
• Prova a tensione AC (EN 50470-3, 7.2)	
• Resistenza della custodia alla fiamma	UL 94

### Morsetti di connessione

• Tipo di gabbia morsetto corrente principale	testa della vite Z +/-
• Tipo di gabbia morsetto uscita impulso	testa della vite a taglio
• Capacità morsetto corrente principale	filo compatto min. (max) filo flessibile con capocorda min. (max)
• Capacità morsetto uscita impulso	filo compatto min. (max) filo flessibile con capocorda min. (max)

### Condizioni ambientali

• Ambiente meccanico	
• Ambiente elettromagnetico	
• Temperatura d'impiego	
• Limite della temperatura di immagazzinaggio e trasporto	
• Umidità relativa (non condensata)	
• Vibrazioni	ampiezza vibrazioni sinusoidali 50 Hz
• Grado di protezione	apparecchio montato frontalmente (morsetti)

(\*) Grado di protezione garantito in un quadro con almeno grado di protezione IP51

## Technical data

ENGLISH

Data in compliance with EN 50470-1, EN 50470-3, EN 62053-23, EN 62053-31

### General characteristics

• Housing	DIN 43880
• Mounting	EN 60715
• Depth	

### Operating features

• Connection	to single / three-phase load (n° wires)
• Storage of energy values and configuration	internal flash memory
• Display tariffs identifier	for active and reactive energy

### Supply

• Rated supply voltage <b>Un</b>	
• Operating range voltage	
• Rated frequency <b>fn</b>	
• Rated power dissipation (max. for phase) <b>Pv</b>	

### Overload capability

• Voltage <b>Un</b>	continuous; phase/phase 1 second: phase/phase continuous; phase/N 1 second: phase/N
• Current <b>I<sub>max</sub></b>	continuous momentary (0,5 s) momentary (10 ms)

### Display (readouts)

• Connection errors and phase out	discernible from phase-sequence indic.
• Display type	LCD - Energy LCD - Largeness instantaneous digit dimensions
• Active energy: 1 display, 8 digit + display import or export (arrow)	1 tariff overflow
• Instantaneous active power: 1 display, 3-digit	
• Instantaneous reactive power: 1 display, 3-digit	
• Instantaneous apparent power: 1 display, 3-digit	
• Instantaneous tariff measurement	1 display, 1-digit
• Transformer primary current	steps of 5 A
• Display period refresh	

### Measuring accuracy

• Active energy and power	acc.to EN 50470-3
• Reactive energy and power	acc.to EN 62053-23

### Measuring input

• Type of connection	
• Voltage <b>Un</b>	phase/phase phase/N phase/phase phase/N
• Operating range voltage	
• Current <b>I<sub>ref</sub></b>	
• Current <b>In</b>	
• Current <b>I<sub>min</sub></b>	
• Operating range current ( <b>I<sub>st</sub> ... I<sub>max</sub></b> )	direct connection transformer connection (CT)
• Transformer current	primary current of the transformer smallest input step adjus. in 5 A steps
• Frequency	
• Input waveform	sinusoidal
• Starting current for energy measurement ( <b>I<sub>st</sub></b> )	

### Pulse output (S0)

• 2 pulse output	acc.to EN 62053-31 1 pulse output energy export 1 pulse output energy import direct connection 80 A convec. CT .../5 A, automat. adjus. (see table)
• Quantity pulse output	
• Pulse duration	
• Required voltage	min ... max
• Permissible current	pulse ON (max 230 V a.c./d.c.)
• Permissible current	pulse OFF (leakage cur. max 230 V a.c./d.c.)

### Optical interfaces

• Front side ( <b>accuracy control</b> )	LED
--	-----

### Laterale IR interfaces

• For communication moduls connection (LAN-TCP/IP / M-Bus / Modbus RTU / RS-485 / KNX-EIB / SD-Card Datalogger)	
---	--

### Safety acc. to EN 50470-1

• Indoor meter	
• Degree of pollution	
• Operational voltage	
• Protective class (EN 50470)	
• Impulse voltage test	
• AC voltage test (EN 50470-3, 7.2)	
• Housing material flame resistance	UL 94

### Connection terminals

• Type cage main current paths	screw head Z +/-
• Type cage pulse output	blade for slotted screw
• Terminal capacity main current paths	solid wire min. (max) stranded wire with sleeve min. (max)
• Terminal capacity pulse output	solid wire min. (max) stranded wire with sleeve min. (max)

### Environmental conditions

• Mechanical environment	
• Electromagnetic environment	
• Operating temperature	
• Limit temperature of transportation and storage	
• Relative humidity (not condensation)	
• Vibrations	50 Hz sinusoidal vibration amplitude
• Degree protection	housing when mounted in front (terminal)

(\*) For the installation in a cabinet at least with IP51 protection.

# Technische Daten

# DEUTSCH

Daten nach EN 50470-1, EN 50470-3, EN 62053-23, EN 62053-31

			ADP3-80C	ADP3-5C
<b>Allgemeine Daten</b>				
• Gehäuse	DIN 43880	DIN	4 Mod.	4 Mod.
• Befestigung	EN 60715	35 mm	DIN	DIN
• Bauhöhe		mm	70	70
<b>Funktion</b>				
• Anschluß	einphasige und dreiphasige Lasten	n° Leiter	2-4	4
• Speicherung der Einstellung und Zählerstand	Digitaldisplay interner Speicher	-	ja-yes-si-oui	ja-yes-si-oui
• Tarife	für Wirk- u. Blindenergie	-	T1	T1
<b>Versorgung</b>				
• Bemessungssteuerspeisespannung <i>Un</i>		V a.c.	230	230
• Spannungsbereich		V	184 ... 276	184 ... 276
• Bemessungsfrequenz <i>fn</i>		Hz	50	50
• Bemessungsverlustleistung (max. für Phase) <i>Pv</i>		VA (W)	≤8 (0.6)	≤8 (0.6)
<b>Überlastbarkeit</b>				
• Spannung <i>Un</i>	Dauerbetrieb: Phase/Phase	V	480	480
	1 Sekunde: Phase/Phase	V	800	800
	Dauerbetrieb: Phase/N	V	276	276
	1 Sekunde: Phase/N	V	300	300
• Strom <i>I<sub>max</sub></i>	Dauerbetrieb	A	80	6
	Kurzbetrieb für (0.5 s)	A	-	120
	Kurzbetrieb für (10 ms)	A	2400	-
<b>Anzeige (Auslesung)</b>				
• Anschlußfehler und Phasenausfall	Anzeige des Drehfeldfehlers	-	PHASE Err	PHASE Err
• Anzeige	LCD - Energie	n° Digits	9 (1 ... 3 Dezimale-Dec.)	9 (1... 3 Dezimale-Dec.)
	LCD - Blitzschneller Umfang	n° Digits	4 (1 ... 3 Dezimale-Dec.)	4 (1... 3 Dezimale-Dec.)
• Wirkenergie: 1 Anzeige, 8-stellig + Anzeige Bezug oder Lieferung (Pfeil)	Digit Abmessungen	mm x mm	6.00 x 3	6.00 x 3
	1 Tarife	Wh	0.01	0.01
• Momentane Wirkleistung: 1 Anzeige, 3-stellig	max Anzeige (Durchlauf)	MWh	9999999.99	9999999.99
		W, kW, MW	000 ... 999.9	000 ... 999.9
• Momentane Blindenergie: 1 Anzeige, 3-stellig		var, kvar, Mvar	000 ... 999.9	000 ... 999.9
		VA, kVA, MVA	000 ... 999.9	000 ... 999.9
• Momentane Blindleistung: 1 Anzeige, 3-stellig				
• Tariferkennung der Anzeige	1 Anzeige, 1-stellig	-	T1	T1
• Wandler Primärstrom	in 5 A Schritte	A	-	5 ... 10.000
• Anzeigezyklus		s	1	1
<b>Messgenauigkeit</b>				
• Wirkenergie und Wirkleistung	nach EN 50470-3	Klasse	B	B
• Blindenergie und Blindleistung	nach EN 62053-23	Klasse	2	2
<b>Messeingang</b>				
• Anschlußart		-	direkt-direct-diret.	Wandler-CT-TA-TC .../5 A
• Spannung <i>Un</i>	Phase/Phase	V	400	400
	Phase/N	V	230	230
• Arbeitsbereich Spannung	Phase/Phase	V	319 ... 480	319 ... 480
	Phase/N	V	184 ... 276	184 ... 276
• Strom <i>I<sub>ref</sub></i>		A	5	-
• Strom <i>I<sub>n</sub></i>		A	-	5
• Strom <i>I<sub>min</sub></i>		A	0.25	0.05
• Arbeitsbereich Strom ( <i>I<sub>st</sub> ... I<sub>max</sub></i> )	Direktanschluss	A	0.015 ... 80	-
	Wandleranschluss	A	-	0.003 ... 6
	Primärstrom des Wandlers	A	-	5 ... 10.000
• Wandlerstrom		A	-	5
	kleinster Eingabeschritt	A	-	5
• Frequenz		Hz	50	50
• Eingangswelligkeitsform		-	sinusförmig	sinusförmig
• Betriebsanlaufstrom ( <i>I<sub>st</sub></i> )		mA	15	3
<b>S0 Schnittstellen</b>				
• Impulsausgänge	nach EN 62053-31			
• Impulsmenge	1 Impulsausgang für Energie-Export	-	ja-yes-si-oui	ja-yes-si-oui
	1 Impulsausgang für Energie-Import	-	ja-yes-si-oui	ja-yes-si-oui
• Impulsdauer	bei 80 A	Imp/kWh	einstellbare, adjust., impostab.	-
	bei Wandler automatisch (siehe Tabelle)	Imp/kWh	-	einstellbar (abhängig von der CT)
• Erforderliche Spannung	min ... max	V a.c (d.c.)	30 ±2 ms	30 ±2 ms
• Zulässiger Strom	Impuls ON (max 230 V a.c./d.c.)	mA	5 ... 230 ±5% (5 ... 300)	5 ... 230 ±5% (5 ... 300)
• Erlaubter Strom	Impuls OFF (Fehlerstrom max 230 V a.c./d.c.)	µA	90	90
<b>Optische Schnittstellen</b>				
• Frontseitige LED ( <i>zur Genauigkeitskontrolle</i> )	LED	imp/kWh	einstellbare, adjust., impostab.	einstellbare, adjust., impostab.
<b>IR-Schnittstellen</b>				
• Seitlich zur Anbindung von Kommunikationsmodulen (LAN-TCP/IP / M-Bus / Modbus RTU / RS-485 / KNX-EIB / SD-Card Datalogger)		-	ja-yes-si-oui	ja-yes-si-oui
<b>Sicherheit nach EN 50470-1</b>				
• für Innenräume		-	ja-yes-si-oui	ja-yes-si-oui
• Verschmutzungsgrad		-	2	2
• Betriebsspannung		V	300	300
• Schutzklasse (EN 50470)		Klasse	II	II
• Prüfspannung		1.2/50 µs-kV	6	6
• AC voltage test (EN 50470-3, 7.2)		kV	4	4
• Flammenwiderstand	UL 94	Klasse	V0	V0
<b>Klemmenanschlüsse</b>				
• Liftklemmen für Betriebs- und Hauptstrombahnen	Schraubenkopf Z +/-	POZIDRIV	PZ2	PZ1
• Liftklemmen für S0 Impulsausgänge	Klinge für Schlitzschraube	mm	0.8 x 3.5	0.8 x 3.5
• Klemmenkapazität Betriebs- und Hauptbahnen	starr min. (max)	mm <sup>2</sup>	1.5 (35)	1.5 (6)
	flexibel, mit Hülse min. (max)	mm <sup>2</sup>	1.5 (35)	1.5 (6)
• Klemmenkapazität für S0 Impulsausgänge	starr min. (max)	mm <sup>2</sup>	0.14 (2.5)	0.14 (2.5)
	flexibel, mit Hülse min. (max)	mm <sup>2</sup>	0.14 (1.5)	0.14 (1.5)
<b>Umweltbedingungen</b>				
• Mechanische Umgebung		-	M1	M1
• Elektromagnetische Umgebung		-	E2	E2
• Betriebstemperatur		°C	-10 ... +55	-10 ... +55
• Temperaturgrenzen für Lagerung und Transport		°C	-25 ... +70	-25 ... +70
• Relative Feuchte (ohne Kondensation)		%	≤80	≤80
• Schwingen	Sinus-Amplitude bei 50 Hz	mm	±0.075	±0.075
• Schutzart	Eingebautes Gerät Frontseite/Klemmen	-	IP51(*)/IP20	IP51(*)/IP20

(\*) Für die Installation in einem Verteiler mit mindestens IP51 Schutz.