

Operating instructions



three-phase digital active and reactive energy-meter with measurement of active and reactive instantaneous power, set up for communication

| Code | Description |
|------------------|--|
| AD3-125C | three-phase digital with direct connection 0.25-5 (125) A 2 tariff - 2 S0 |
| AD3-125MC | three-phase digital with direct connection 0.25-5 (125) A 2 tariff - 2 S0 (MID calibrated) |

WARNING

Installation must be carried out and inspected by a specialist or under his supervision. When working on the instrument, switch off the mains voltage!

1) Quantities displayed

1a) Energy

They are displayed on the main 8 digits counter:

| Ref. | Energy | Unit | Symbol | ΣL | L1 | L2 | L3 | Tariff |
|-----------|-------------------|-------------|--------|----|----|----|----|--------|
| E1 | Active Absorbed | MWh/kWh | → | • | • | • | • | T1 |
| E2 | Active Supplied | MWh/kWh | ← | • | • | • | • | T1 |
| E3 | Reactive Absorbed | Mvarh/kvarh | → | • | • | • | • | T1 |
| E4 | Reactive Supplied | Mvarh/kvarh | ← | • | • | • | • | T1 |
| E5 | Active Absorbed | MWh/kWh | → | • | • | • | • | T2 |
| E6 | Active Supplied | MWh/kWh | ← | • | • | • | • | T2 |
| E7 | Reactive Absorbed | Mvarh/kvarh | → | • | • | • | • | T2 |
| E8 | Reactive Supplied | Mvarh/kvarh | ← | • | • | • | • | T2 |

1b) Power

Powers are displayed on the bar indicator and also on the 3 digits secondary counter:

| Ref. | Power | Unit | Symbol | ΣL | Tariff |
|-----------|---------------------|---------------|--------|----|--------|
| P1 | Active Absorbed | MW/kW/W | → | • | T1 |
| P2 | Active Supplied | MW/kW/W | ← | • | T1 |
| P3 | Reactive Inductive | Mvar/kvar/var | ε | • | T1 |
| P4 | Reactive Capacitive | Mvar/kvar/var | ⊖ | • | T1 |
| P5 | Active Absorbed | MW/kW/W | → | • | T2 |
| P6 | Active Supplied | MW/kW/W | ← | • | T2 |
| P7 | Reactive Inductive | Mvar/kvar/Var | ε | • | T2 |
| P8 | Reactive Capacitive | Mvar/kvar/Var | ⊖ | • | T2 |

2) Display View (see quantities displayed)

- A green backlighted LCD display.
- With the front push button all register will appear.

3) User informations

A quantity of informations are available on the display. They are divided into 4 groups:

| | |
|----------|---|
| A | Default Page (currently growing Active Energy) |
| B | System Energy Registers (ΣL) |
| C | Phases Energy Registers (L1, L2 and L3) |
| D | Diagnostic Page |

A) Default Page (currently growing Active Energy)

- The value of the currently growing Active 3-phase Energy is represented (or the last one that has grown).
- The Energy is always Active, and may be Active Consumed (right arrow), Active Generated (left arrow), with Tariff T1 or T2, depending on the current Energy flowing.
- The value of currently flowing Active Power is visible (3 digits field), together with a dedicated bar-graph representing the percentage of the flowing power (10% division of the bar graph)
- A short keypress of the "command button" switches the backlight ON.
- A further short keypress enable the visualisation of system energy registers.
- If the command button is not pushed for 40 seconds, the backlight is automatically switched off, and the display returns to the default page

B) System Energy Registers (ΣL) E1 to E8 see Table

- This group is dedicated to show the System (ΣL) Energy registers, E1 to E8, as described in the above table.
- A short keypress of the "command button" allows to see all 8 registers, one at a time
- If the current rate corresponds to that of energy represented on the display, also the power and the bar-graph are represented
- By keeping the command button pushed for at least 4 seconds, the L1 Phase Energy registers group representation on display is enabled. If the command button is not pushed for 40 seconds, the backlight is automatically switched off, and the display returns to the default page

C) Phases Energy Registers (L1, L2 and L3) E1 to E8 see Table

- This group is dedicated to show the Phase Registers (with the same criteria of the System Energy registers). Initially, L1 group registers are displayed. A short keypress of the "command button" allows to see all 8 registers, one at a time
- By keeping the command button pushed for at least 4 seconds (less than 10 seconds), the L2 Phase Energy registers group representation on display is enabled. In the same way, once selected L2 registers, one can push the button for 4 seconds and start to see the L3 registers group.
- If the command button is not pushed for 40 seconds, the backlight is automatically switched off, and the display returns to the default page
- By keeping the command button pushed for at least 10 seconds, the diagnostic page is enabled

D) Diagnostic Page

- All display segments are activated, thus allowing the operator to see if the display is correctly working. By keeping the command button furtherly pushed, it is possible to see the value of the Firmware Release and of the Flash Checksum
- If the command button is not pushed for 40 seconds, the backlight is automatically switched off, and the display returns to the default page

3.1) Zeroing all registers (only AD3-125C model)

- A pressure of 20 sec. of the "command button" allows to enter in the zeroing menu and on the display appears "rESEt".
- The button must be released. To do the reset press it again for 4 sec., afterwards it will go back to the default visualization with all registers reset.
- After 4 sec. from the button release if the "command reset" is not done, it will go back to the default visualization without the reset.
- Zero setting not available into products with MID certification

3.2) Error condition

- When the display shows the message "Err0r 01" or "Err0r 02", the meter has got a malfunction and must be replaced.

Display

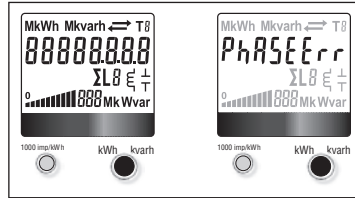

kWh kvarh
MWh Mvarh

T8

ΣL

⊖

ε



1000 imp/kWh

kWh kvarh

- MWh/kWh display
- Mvarh/kvarh display

- Tarif Running tarif, called tarif (T1-T2)

- Phase summary line energy

- Displays capacitive, reactive power

- Displays inductive, reactive power

- Consumption Bar display (percentage of Pmax)

- Precision control LED

- Readout selection push button

88888888



L8

888

- Connection errors and phase out

- Energy value

- Energy export (absorbed →)

- Energy import (supplied ←)

- Energy line (L1-2-3)

- Running active power display

Dimension

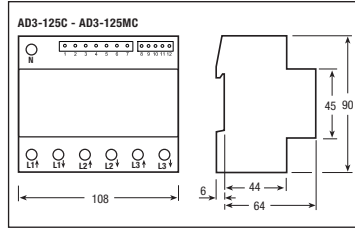

Sealable terminal covers

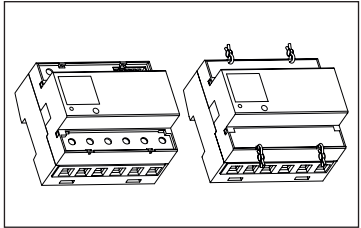

MID calibrated AD3-125MC

- A)** Device code and certification data indications

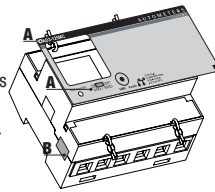

- B)** Safety-sealing between upper and lower housing part

Cable stripping length and max. terminal screw torque

125 A direct connection main terminals
Screw driver P22

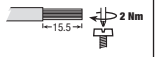

Tariff and communication terminals - Screw driver blade 0.8x3.5 mm

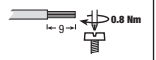

Wiring diagram

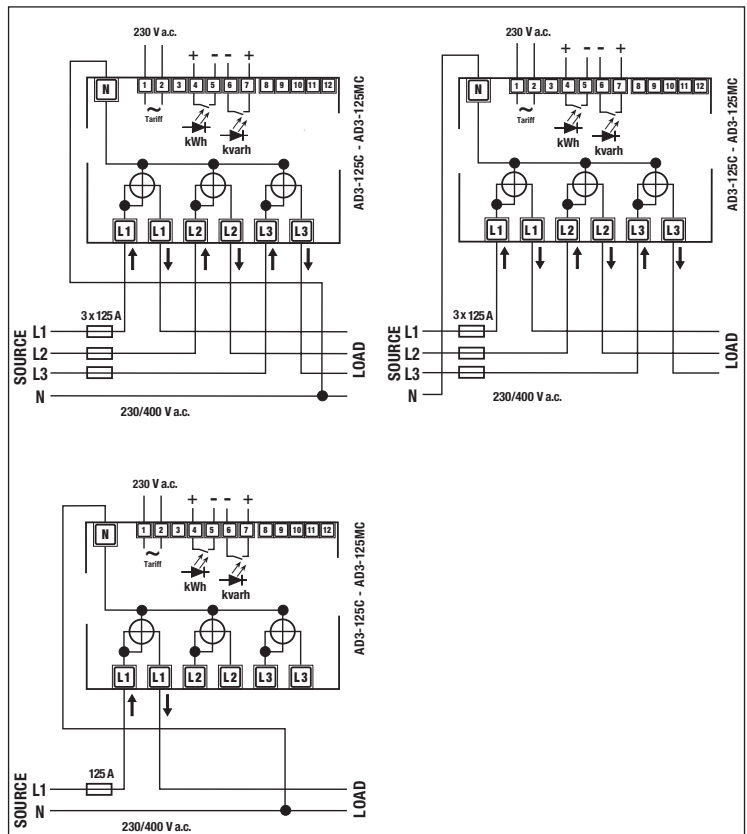

"Wire N needs to be connected to the meter"

Technical data

Data in compliance with EN 50470-1, EN 50470-3, EN 62053-23, EN 62053-31

AD3-125C
AD3-125MC

General characteristics

| | | | |
|------------|-----------|-------|-----------|
| • Housing | DIN 43880 | DIN | 6 modules |
| • Mounting | EN 60715 | 35 mm | DIN rail |
| • Depth | | mm | 70 |

Operating features

| | | | |
|--|--------------------------------|----------|-----------|
| • Connectivity | to single/three-phase network | n° wires | 2-4 |
| • Storage of energy values and configuration | digital display (EEPROM) | - | yes |
| • Display tariffs identifier | for active and reactive energy | n° 2 | T1 and T2 |

Supply

| | | | |
|--|--|--------|-------------|
| • Rated control supply voltage <i>Un</i> | | VAC | 230 |
| • Operating range voltage | | V | 184 ... 276 |
| • Rated frequency <i>fn</i> | | Hz | 50 |
| • Rated power dissipation (max. for phase) <i>Pv</i> | | VA (W) | ≤8 (0.6) |

Overload capability

| | | | |
|----------------------------------|-------------------------|---|------|
| • Voltage <i>Un</i> | continuous; phase/phase | V | 480 |
| | 1 second: phase/phase | V | 800 |
| | continuous; phase/N | V | 276 |
| | 1 second: phase/N | V | 300 |
| • Current <i>I_{max}</i> | continuous | A | 125 |
| | momentary (10 ms) | A | 3750 |

Display (readouts)

| | | | |
|---|--|-------------------|---------------|
| • Connection errors and phase out | discernible from phase-sequence indication | - | Phase Err |
| • Display type | LCD | n° digits | 8 (2 decimal) |
| | digit dimensions | mm x mm | 6.00 x 3 |
| • Active energy: 1 display, 8 digit + display import or export (arrow) | tariffs 2 | Wh | 0.01 |
| | overflow | MWh | 999999.99 |
| • Reactive energy: 1 display, 8 digit + display import or export (arrow) | tariffs 2 | varh | 0.01 |
| | overflow | Mvarh | 999999.99 |
| • Instantaneous active power: 1 display, 3 digit | | W, kW or MW | 000 ... 999 |
| • Instantaneous reactive power: 1 display, 3 digit | | var, kvar or Mvar | 000 ... 999 |
| • Instantaneous tariff measurement | | - | 1 |
| | 1 display, 1-digit | - | T1 or T2 |
| • Display period refresh | | s | 1 |

Measuring accuracy

| | | | |
|-----------------------------|--------------------|---------|---|
| • Active energy and power | acc.to EN 50470-3 | class 1 | B |
| • Reactive energy and power | acc.to EN 62053-23 | class 2 | 2 |

Measuring input

| | | | |
|---|-------------------|----|---------------|
| • Type of connection | | - | direct |
| • Voltage <i>Un</i> | phase/phase | V | 400 |
| | phase/N | V | 230 |
| • Operating range voltage | phase/phase | V | 319 ... 480 |
| | phase/N | V | 184 ... 276 |
| • Current <i>I_{ref}</i> | | A | 5 |
| • Current <i>I_{min}</i> | | A | 0.25 |
| • Operating range current (<i>I_{st} ... I_{max}</i>) | direct connection | A | 0.020 ... 125 |
| • Frequency | | Hz | 50 ±2% |
| • Input waveform | | - | sinusoidal |
| • Starting current for energy measurement (<i>I_{st}</i>) | | mA | 20 |

Pulse output SO

| | | | |
|-------------------------|--|----------|---------------------------|
| • Pulse output | acc.to EN 62053-31 for active and reactive energy T1 and T2 | - | yes |
| • Quantity pulse output | | Imp/kWh | 500 |
| • Pulse duration | | ms | 30 ±2 ms |
| • Required voltage | min. (max.) | VAC (DC) | 5 ... 230 ±5% (5 ... 300) |
| • Permissible current | pulse ON (max. 230 V AC/DC) | mA | 90 |
| • Permissible current | pulse OFF (leakage cur. max. 230 V AC/DC) | µA | 1 |

Optical interfaces

| | | | |
|--|-----|---------|------|
| • Front side (<i>accuracy control</i>) | LED | imp/kWh | 1000 |
|--|-----|---------|------|

Safety acc. to EN 50470-1

| | | | |
|---|-------|--------------|-----|
| • Indoor meter | | - | yes |
| • Degree of pollution | | - | 2 |
| • Operational voltage | | V | 300 |
| • AC voltage test (EN 50470-3, 7.2) | | kV | 4 |
| • Impulse voltage test | | 1.2/50 µs-kV | 6 |
| • Protection class (EN 50470) | | class | II |
| • Housing material flame resistance | UL 94 | class | V0 |
| • Safety-sealing between upper and lower housing part (mod. AD3-125MC) | | - | yes |

Lateral IR interfaces

| | | | |
|---|--|---|-----|
| • For communication moduls connection (LAN-TCP/IP / M-Bus / Modbus RTU / KNX-EIB / SD-Card Datalogger) | | - | yes |
|---|--|---|-----|

Connection terminals

| | | | |
|--|---------------------------------------|-----------------|-----------|
| • Type cage main current paths | screw head Z +/- | POZIDRIV | PZ2 |
| • Type cage pulse output | blade for slotted screw | mm | 0.8 x 3.5 |
| • Terminal capacity main current paths | solid wire min. (max.) | mm ² | 1.5 (50) |
| | stranded wire with sleeve min. (max.) | mm ² | 1.5 (50) |
| • Terminal capacity pulse output | solid wire min. (max.) | mm ² | 1 (4) |
| | stranded wire with sleeve min. (max.) | mm ² | 1 (2.5) |

Environmental conditions

| | | | |
|---|--|----|--------------|
| • Mechanical environment | | - | M1 |
| • Electromagnetic environment | | - | E2 |
| • Operating temperature | | °C | -10 ... +55 |
| • Limit temperature of transportation and storage | | °C | -25 ... +70 |
| • Relative humidity (not condensation) | | % | ≤80 |
| • Vibrations | 50 Hz sinusoidal vibration amplitude | mm | ±0.075 |
| • Degree protection | housing when mounted in front (terminal) | - | IP51(*)/IP20 |

(*) For the installation in a cabinet at least with IP51 protection.