

## A-100 Series

Single Phase Two Wires DIN rail Meter



User Manual U1.8

### Warnings

Important Safety Information is contained in the Maintenance section. Familiarize yourself with this information before attempting installation or other procedures.

- Risk of Danger:** These instructions contain important safety information. Read them before starting installation or servicing of the equipment.
- Caution:** Risk of Electric Shock

## 1.Introduction

This document provides operating, maintenance and installation instructions for the A-100 series 1 phase 2 wire din rail mounted kWh meters. The A-100 range of meters has four models in the range Starting with the basic A-100P (Pulse Output) to the better communication meters A-100M, A-100MT (RS485 Modbus) and the A-100B (M-Bus). The Bi directional measurements makes the meter suitable for Active and reactive energy for all power monitoring applications including the new Solar PV requirements for measuring Energy. The A-100MT has the facility for being able to program four tariffs with its built in time switch for monitoring energy in different periods.

Model	Measurements	Communication	Pulse Outputs	Multi Tariffs
A-100M	U, I, P, Q, PF, Hz, Dmd, kWh, kVarh, Import, Export	RS485 Modbus	1: configurable 2: 1000imp/kwh	NO
A-100M-B	U, I, P, Q, PF, Hz, Dmd, kWh, kVarh, Import, Export	M-bus EN13757-3	1: configurable 2: 1000imp/kwh	NO
A-100P	U, I, P, Q, PF, Hz, Dmd, kWh, kVarh, Import, Export	NO	1: configurable 2: 1000imp/kwh	NO
A-100MT	U, I, P, Q, PF, Hz, Dmd, kWh, kVarh, Import, Export	RS485 Modbus	1: configurable 2: 1000imp/kwh	4 Tariffs (RTC)

### 1.1 Key Characteristics

- Bi-directional measure and display
- Multi-function measurements
- Two Pulse outputs
- RS485 Modbus / M-bus
- 100A direct connection
- Two module size (35mm)
- Password protected set-up
- Backlighted LCD
- Multi-tariff

### 1.2 Pulse output

The meter provides two pulse outputs. Both pulse outputs are passive type. Pulse output 1 can be set to generate pulses to represent total / import/export kWh or kVarh. The pulse constant can be set to generate 1 pulse per: 0.001(default)/0.01/0.1/kWh/kVarh. Pulse width: 200/100/60ms Pulse output 2 is non-configurable. It is fixed up with active kWh (Imp). The constant is 1000imp/kWh.

### 1.3 RS485 Serial – Modbus RTU

Rs485 serial port with Modbus RTU protocol to provide a means of remotely monitoring and controlling the Unit. Set-up screens are provided for setting up the RS485 port.

### 1.4 Mbus for A-100M-B

This unit has an M-BUS serial port with M-BUS protocol to provide a means of remotely monitoring and controlling the Unit Set-up screens are provided for setting up the M-bus port.

### 1.5 4T by RTC for A-100MT

The internal clock circuit of this unit has time automatic switching function. Calendar, clock and rate can be set and adjustment through RS485, infrared interface. At least 4 tariffs and 10 time segments can be set within a natural day.

## 2.Operation

### 2.1 LCD Display

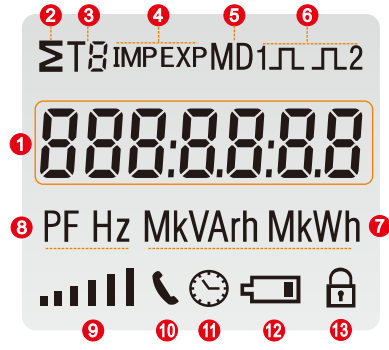

NO.	Descriptions
1	7 digits used to display measured values or RTC
2	Total value
3	Tariff information
4	Import information, Export information
5	Max. Demand for Power or Current.
6	Pulse output 1 and Pulse output 2
7	Measurement units
8	PF = power factor Hz = frequency
9	Bar display of Power
10	Communication indicator
11	Time information
12	Low battery warning
13	Lock symbol

### 2.2 Initialization Display

	All display segments light up, display check.
	Software version (please check the real software version on the product as the final).
	Modbus ID or Mbus Primary Address.
	Mbus Secondary Address (High)
	Mbus Secondary Address (Low)
	Baud rate.
	Total kWh.

### 2.3 Scroll display by Buttons

After initialization and self-checking program, the meter display the measured values. The default page is total kWh. If the user wants to check other information, he needs to press the scroll button on the front panel.

The display order by scroll button :

#### \*For A-100M:

Total kWh → Import kWh → Export kWh → total kVarh → Import kVarh → Export kVarh → Max. Power Demand → Voltage → Current → W → Var → VA → Power Factor → Frequency → Pulse Constant → Modbus ID → Baud Rate Display No: 1~3, 8~10, 15, 20~29.

#### \*For A-100P:

Total kWh → Import kWh → Export kWh → Total kvarh → Import kVarh → Export kVarh → Max. Power Demand → Voltage → Current → W → Var → VA → Power Factor → Frequency → Pulse Constant → Modbus ID → Baud Rate Display No: 1~3, 8~10, 15, 20~27.

#### \*For A-100M-B:

Total kWh → Import kWh → Export kWh → Total kVarh → Import kVarh → Export kVarh → Max. Power Demand → Voltage → Current → W → Var → VA → Power Factor → Frequency → Pulse Constant → Mbus Primary Address → Mbus Secondary Address → Baud Rate Display No: 1~3, 8~10, 15, 20~29.

#### \*For A-100MT:

Total kWh → Import kWh → Export kWh → T1 kWh → T2 kWh → T3 kWh → T4 kWh → Total kVarh → Import kVarh → Export kVarh → T1 kVarh → T2 kVarh → T3 kVarh → T4 kVarh → Max. Power Demand → T1 Max. Power Demand → T2 Max. Power Demand → T3 Max. Power Demand → T4 Max. Power Demand → Voltage → Current → W → Var → VA → Power Factor → Frequency → Pulse Constant → Modbus ID → Baud Rate → Date → Time → Time Segment 1 → Time Segment 2 → Time Segment 3 → Time Segment 4 → Time Segment 5 → Time Segment 6 → Time Segment 7 → Time Segment 8 → Time Segment 9 → Time Segment 10 Display No: 1~41.

#### Scroll display by buttons:

No.	Picture	Descriptions
1		Total active energy Example: 70.00kWh
2		Import(input) active energy Example: 50.00kWh
3		Export(output) active energy Example: 20.00kWh
4		T1 active energy Example: 10.00kWh
5		T2 active energy Example: 10.00kWh
6		T3 active energy Example: 30.00kWh
7		T4 active energy Example: 20.00kWh
8		Total reactive energy Example: 10.00kVarh
9		Import(input) reactive energy Example: 5.00kVarh
10		Export(output) reactive energy Example: 5.00kVarh
11		T1 reactive energy Example: 2.00kVarh
12		T2 reactive energy Example: 2.00kVarh
13		T3 reactive energy Example: 2.00kVarh
14		T4 reactive energy Example: 4.00kVarh
15		Max Power Demand Example: 6938W
16		T1 Max. Power Demand Example: 0W

17		T2 Max. Power Demand Example: 0W
18		T3 Max. Power Demand Example: 0W
19		T4 Max. Power Demand Example: 0W
20		Voltage Example: 229.8V
21		Current Example: 30.156A
22		Active Power Example: 4700W
23		Reactive Power Example: 1030Var
24		Apparent power Example: 4811VA
25		Power factor Example: 1.000
26		Frequency Example: 49.99Hz
27		Pulse 2 Constant Example: 1000
28		Modbus Address Example: 001 Mbus primary address Example: 001
28-1		Low bit of MBUS Secondary address (Default 00 01) Example: if the Secondary address high bit is 0000, low bit is 0001, that means the integral Secondary address is 00 00 00 01
29		Baud rate Example: 9600
30		Date Format: Day, Month, Year Example: 1st, Jan, 2015
31		Time Format: Hour, Minute, Second Example: 00:02:39
32		Time segment 1 Format: Hour:Minute, Tariff Example: 00:00, Tariff 1
33		Time segment 2 Format: Hour:Minute, Tariff Example: 02:00 Tariff 2

34	T3 04:00:03	Time segment 3 Format:Hour:Minute,Tariff Example:04:00 Tariff 3
35	T4 05:00:04	Time segment 4 Format:Hour:Minute,Tariff Example:05:00 Tariff 4
36	T5 07:25:01	Time segment 5 Format:Hour:Minute,Tariff Example:07:25 Tariff 1
37	T6 08:11:02	Time segment 6 Format:Hour:Minute,Tariff Example:08:11 Tariff 2
38	T7 15:40:03	Time segment 7 Format:Hour:Minute,Tariff Example:15:40 Tariff 3
39	T8 17:00:04	Time segment 8 Format:Hour:Minute,Tariff Example:17:00 Tariff 4
40	T9 19:00:01	Time segment 9 Format:Hour:Minute,Tariff Example:19:00 Tariff 1
41	T0 23:00:02	Time segment 10 Format:Hour:Minute,Tariff Example:23:00 Tariff 2

## 2.4 Set-up Mode

To get into Set-up Mode, the user needs to press the "Enter" button  for 3 seconds.

	Good	The setting is done correctly
	Err	The entering information is wrong. The operation fails.
1	PR5 0000	Password To get into Set-up mode, it asks a password confirmation. Default password: 1000
2	Add 001	Address For Modbus: Default ID is 001 Range: 001-247 For Mbus: Primary Address ID Default ID is 001 Range:001-250
2-1	Add 001	Press the "Enter" button, the first digit flash.Press the "Scroll" button to change the value. After choose the new address value, the user need pressing the "Enter" button to confirm the setting.
2-2	1dH 0000	High bit of MBUS Secondary address(Default 00 00)
	1dL 0001	Low bit of MBUS Secondary address(Default 00 01) Example: if the Secondary address high bit is 0000,low bit is 0001, that means the integral Secondary address is 00 00 00 01
2-3		Press the "Enter" button, the red part flash. Press the "Scroll" button to change the option. After choose the new value, the user need pressing the "Enter" button to confirm the setting.
3	bd 9600	Baud rate for Modbus Default value: 2400bps Range: 1200, 2400, 4800, 9600bps. Baud rate for Mbus: Default value: 2400bps Range:300, 600, 1200, 2400, 4800, 9600bps.
3-1	bd 9600	Press the "Enter" button, the red digit flash.Press the "Scroll" button to change the value. After choose the new baud rate, the user need pressing the "Enter" button to confirm the setting.

4	Prty n	Parity Default: None Option: None, Even, Odd
4-1	Prty n	Press the "Enter" button, the red part flash. Press the "Scroll" button to change the option. After choose the new Parity, the user need pressing the "Enter" button to confirm the setting.
5	PLS out kWh	Pulse Output 1 Default: kWh Option:kWh / KVarh / Imp. kWh / Exp. kWh / Imp.kVarh / Exp.kVarh
5-1	PLS out kWh	Press the "Enter" button, the red part flash.Press the "Scroll" button to change the option. After choose the new Pulse output option, the user need pressing the "Enter" button to confirm the setting.
6	PLS cSt	Pulse Constant Default: 1000 Option: 1000 / 100 / 10 / 1
6-1	cSt 1000	Press the "Enter" button, the red part flash.Press the "Scroll" button to change the option. After choose the new Pulse constant option, the user need pressing the "Enter" button to confirm the setting.
7	PLS t	Pulse duration Default: 100mS Option: 200 / 100 / 60ms
7-1	PLS t 200	Press the "Enter" button, the red part flash.Press the "Scroll" button to change the option. After choose the new Pulse duration option, the user need pressing the "Enter" button to confirm the setting.
8	dIt 5Et	Demand Integration Time Default: 15 minutes Option: off(0) / 5 / 10 / 15 / 30 / 60
8-1	dIt 15	Press the "Enter" button, the red part flash.Press the "Scroll" button to change the option. After choose the new DIT option, the user need pressing the "Enter" button to confirm the setting.
9	Scrl t	Automatic Scroll Time Interval Default: 0 S Option: 0 - 30S
9-1	t 30 S	Press the "Enter" button, the red part flash.Press the "Scroll" button to change the option. After choose the new "Scrl" option, the user needs to press the "Enter" button to confirm the setting.
10	SEt PR55	Password set-up Default: 1000
10-1	PR5 1000	Press the "Enter" button, the red part flash.Press the "Scroll" button to change the option. After choose the new "Scrl" option, the user needs to press the "Enter" button to confirm the setting.
11	SEt dAtE	Date set-up Press the "Enter" button to enter the date set-up page.
11-1	0 10 100	Press the "Scroll" button to change the value. After choose the new value, the user need pressing the "Enter" button to confirm the setting. Date format:Day,Month,Year
12	SEt rTc	Time set-up Press the "Enter" button to enter the time set-up page
12-1	00:04:33	Press the "Scroll" button to change the value. After choose the new value, the user need pressing the "Enter" button to confirm the setting. Time format:Hour:Minute:Second

## 3.Specifications

### 3.1 Accuracy

Voltage	0.5% of range maximum
Current	0.5% of nominal
Frequency	0.2% of mid-frequency
Active power	1% of range maximum
Reactive power	1% of range maximum
Apparent power	1% of range maximum
Active energy	Class 1 IEC62053-21 Class B EN50470-3
Reactive energy	1%of range maximum

### 3.2 General Specifications

Voltage AC (Un)	230V
Voltage Range	176-276V AC
Base Current (Ib/Iref)	5A
Max. Current (Imax)	100A
Mini Current (Imin)	0.25A
Starting current	0.4% of Ib/Iref
Power consumption	<2W/10VA
Frequency	50Hz(for MID version) 50/60Hz±2%(for non-MID version)
AC voltage withstand	4KV for 1 minute
Impulse voltage withstand	6KV-1.2uS waveform
Over current withstand	30Imax for 0.01s
Pulse 1 output rate	configurable, default 1000i/kWh
Pulse 2 output rate	non-configurable, 1000i/kWh
Display	LCD with backlit
Max. Reading	99999.99kWh

### 3.3 Environment

Operating temperature	-25°C to +55°C
Storage/transportation temperature	-40°C to +70°C
Reference temperature	23°C ± 2°C
Relative humidity	0 to 95%, non-condensing
Installation category	CAT II
Mechanical Environment	M1
Electromagnetic environment	E2
Degree of pollution	2

\*Maximum operating and storage temperatures are in the context of typical daily and seasonal variation.

### 3.4 Pulse Output

The pulse output 1 can be set to generate pulses to represent total kWh, total kVarh, import kWh, export kWh, import kVarh, export kVarh.  
Constant can be set to 1000/100/10/1 impulse per kWh or Kvarh. Pulse width 200/100/60ms.

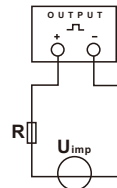

ATTENTION: Pulse output must be fed as shown in the wiring diagram below. Scrupulously respect polarities and the connection mode. Opto-coupler with potential-free SPST-NO Contact. Contact range:5-27VDC Max. current Input:27mADC.

### 3.5 RS485 output for Modbus RTU

The meter provides a RS485 port for remote communication. Modbus RTU is the protocol applied. For Modbus RTU, the following RS485 communication parameters can be configured from the Set-up menu.  
Baud rate: 1200, 2400, 4800, 9600  
Parity: NONE/EVEN/ODD  
Stop bits: 1 or 2  
Modbus Address: 1 to 247

### 3.6 Mbus

The meter provides a M-bus Port for remote communication. the meter adopts EN1434-3 Mbus communication protocol. The communication parameters can be configured via the SET-UP mode.  
Baudrate: 300, 600, 1200, 2400, 4800, 9600  
Parity: None/Odd/Even  
Stop bit: 1 or 2  
Primary address: 001-250  
Secondary address: 00000001-99999999

### 3.7 Mechanics

Din rail dimensions	35x92x65 (WxHxD) Per DIN 43880
Mounting	DIN rail 35mm
Sealing	IP51 (indoor)
Material	self-extinguishing UL94V-1

## 4.Dimensions

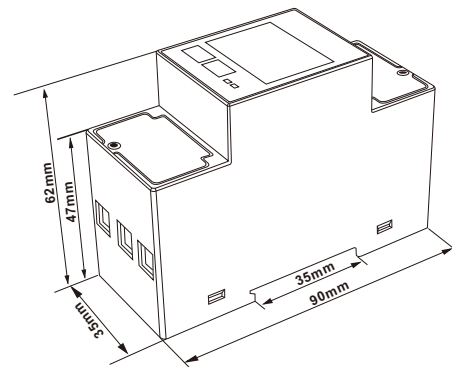

### Declaration of Conformity(for the MID approved version meter only)

We Autometers Systems Ltd.  
Declare under our sole responsibility as the manufacturer that the poly phase multifunction electrical energy meter "A-100 series" correspond to the production model described in the EC-type examination certificate and to the requirements of the Directive 2004/22/EC EC type examination certificate number 0120/SGS0186. Identification number of the NB0120

## 5.Installation and sealing

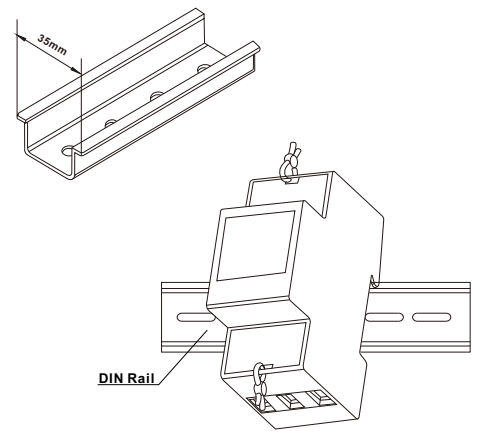

## 6.Wiring diagram

### 6.1 A-100M / MT

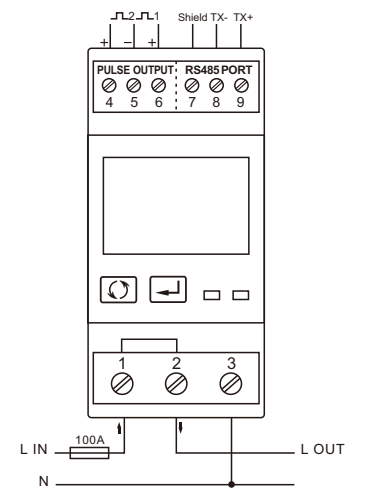

### 6.2 A-100P

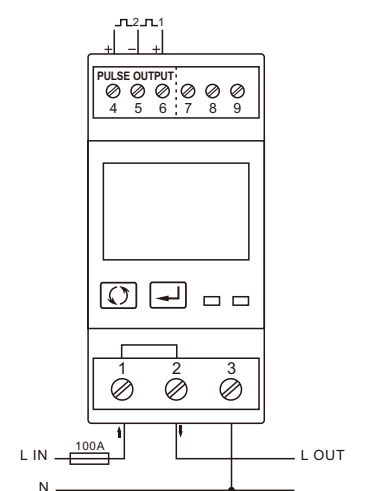

### 6.3 A-100M-B

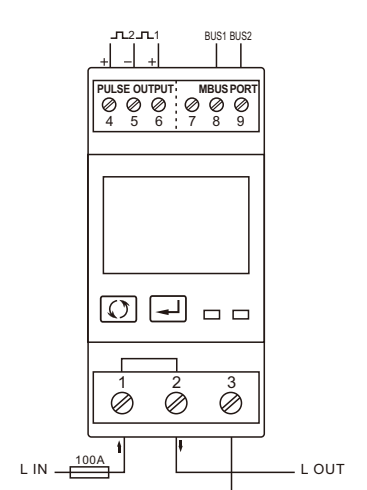

Autometers Systems Ltd  
4B Albany Road, Manchester, M21 0AW  
Tel:00 (44) 0161 861 9056  
Fax:00 (44) 0161 881 3745  
Web:autometers.co.uk

