

# INFORMATION CENTRE IC 1095

MID Approved Multifunction Energy Analyzer with Harmonics.

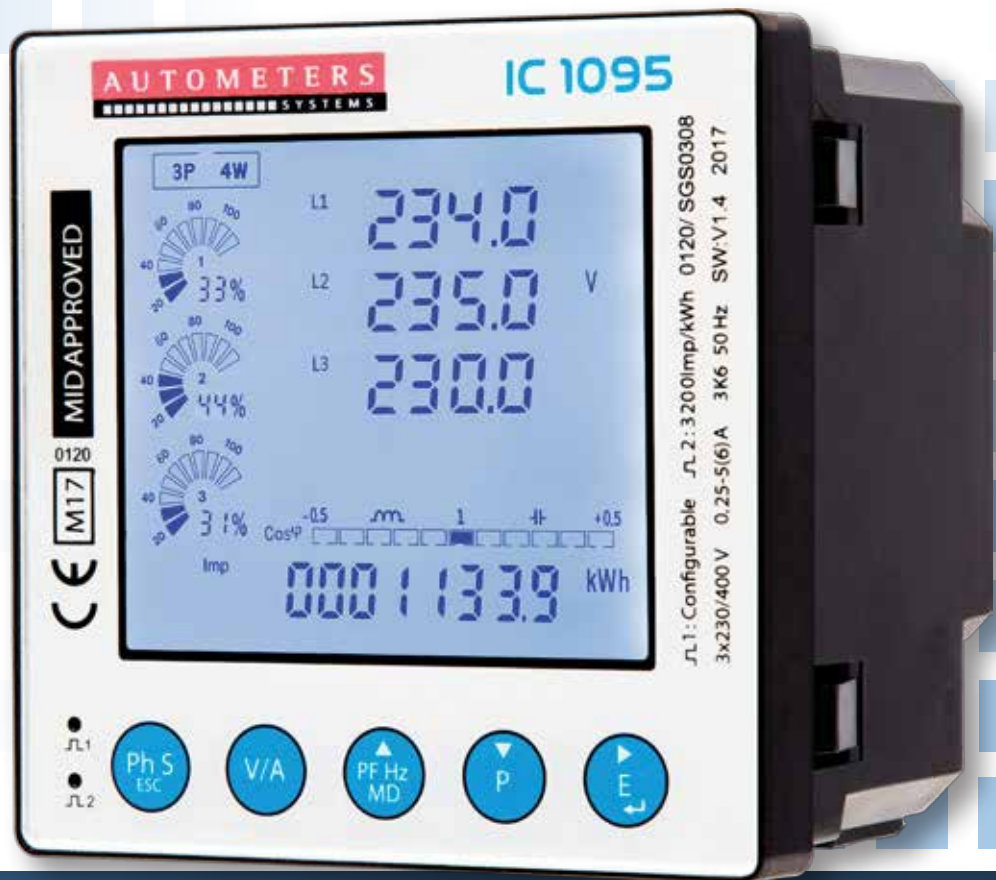

- MID Approved (SGS.UK) Appendix B and D
- Measures kWh, KVArh, KVar, PF, Hz, Max demand
- Total Harmonic Distortion of Voltage and Current
- 2ND ~ 63RD Individual Harmonic Distortion
- RS 485 Modbus (Autometers V6 protocol)
- Two Pulse Outputs
- BI- Directional Measurement for Import and Export
- Back light LCD for full viewing Angles
- Circular bar graph indication per phase
- Line bar graph indication for Power factor
- Available as 1 Phase 2 Wire, 3 Phase 3 Wire and 3 Phase 4 Wire
- 1 or 5 Amp current transformer connection
- All connections are plug in

**AUTOMETERS**  
SYSTEMS

# Introduction

The Information Centre 1095 is a multifunction energy analyzer and is the latest in a new generation of MID approved intelligent panel meters used not only in the electricity transmission and power distribution system, but also in the power consumption measurement and analysis in high voltage intelligent power grid.

The 1095 is capable of measuring electricity in one phase two wire, three phase three wire or three phase four wire electrical systems.

The meter is a 96 x 96mm panel mounted meter designed to be easy to use and easy to read, the meter comes with five control buttons for scrolling and programming with a large back light display for ease of reading. See picture opposite.

The meter displays the following information: Voltage, Frequency, Current, Power active and reactive energy, imported or exported, Power factor, Max. Demand and Harmonics distortion measurement on current and voltage to the 63rd.

Energy is measured in terms of kWh, kVArh. Maximum demand current can be measured over preset periods of up to 60minutes. In order to measure energy the unit requires voltage and current inputs.

The IC 1095 is a 1 amp or 5 amp current operating measuring device and can only work with current transformers. Due to the design of the 1095 it is fully programmable via the front keys to enable a wide range of settings to match any current transformer manufactured.



The Information Centre can be supplied with a pulse Output or Autometers RS 485 Modbus protocol v.6. Configuration is password protected.

This document provides operating, maintenance and installation instructions for the Autometers Information Centre 1095.



# I. Unit Characteristics

## 1.1 The Unit can measure and display:

- Line voltage and THD% (total harmonic distortion) of all phases
- 2~63rd voltage IHD% (Individual Harmonic distortion) of all phases
- Line Frequency
- Currents, Current demands and current THD% of all phases
- 2~63rd current IHD% of all phases
- Active power, reactive power, apparent power, maximum power demand and power factor
- Active energy imported and exported
- Reactive energy imported and exported
- Energy of each phase

### IMPORTANT NOTICE

The IC 1095 is a MID approved panel meter, once you have altered any of the parameters e.g. Current transformer ratio or voltage ratio and you have come out of the programming mode you cannot alter them again.  
This rule does not apply to the Modbus settings.

## 1.2 The unit has password-protected set-up screens for:

- Communication setting: Modbus address, Baud rate, Parity, Stop bit
- CT setting: CT 1 ( Primary) , CT2 ( Secondary), CT rate
- PT setting: PT1 (Primary), PT2 (Secondary) , PT rate
- Pulse setting: Pulse output 1, Pulse rate, Pulse time
- Demand setting: Demand interval time, demand method
- Time setting: Backlit time, display scroll time
- System configuration: System type, System connect, Change password, Auto display scroll
- Reset

## 1.3 CT and PT

CT1 (primary current) 5~9999A  
 CT2 (secondary current): 1A or 5A  
 PT1 (primary voltage): 100V ~ 500,000V  
 PT2 (secondary voltage): 100 to 480 V AC (L-L)



## 1.4 RS485 Serial-Modbus RTU

This unit uses a RS485 serial port with Modbus RTU protocol to provide a means of remote monitoring and controlling.  
Please check section 5.2 for the details of setting.

## 1.5 Pulse output



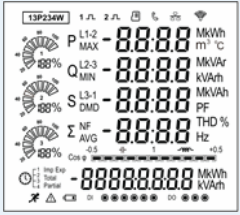

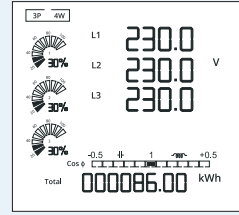
Two pulse outputs indicate real-time energy measurement. Pulse output 1 is configurable, pulse output 2 is fixed to active energy, 3200imp/kWh.

## 2. Start up screens



			
<p>The first screen lights all LED segments and can be used as a display LED check</p>	<p>The second screen indicates the software version of the unit. (the above picture is just for reference)</p>	<p>The unit performs a self-test and the screen indicates if the test is passed.</p>	<p>After a short delay, the default measurement screen appears.</p>



## 3. Keys and Displays

### 3.1 Button Functions

Button	Click	Press and hold down for 3 seconds
	<ul style="list-style-type: none"> <li>■ Display power, voltage, current and energy information of each phase</li> <li>■ Escape the menu</li> </ul>	<ul style="list-style-type: none"> <li>■ Automatic Scroll display ON / OFF</li> </ul>
	<ul style="list-style-type: none"> <li>■ Display voltage and current information of the selected system type. (3p4w, 3p3w and 2p1w)</li> <li>■ Left side move</li> </ul>	<ul style="list-style-type: none"> <li>■ Individual Harmonic Distortion of Voltage up to 63rd</li> </ul>
	<ul style="list-style-type: none"> <li>■ Display power factor, frequency, Max. Demand. Maximum and Minimum value.</li> <li>■ Up page or add value</li> </ul>	<ul style="list-style-type: none"> <li>■ Individual Harmonic Distortion of Current up to 63rd</li> </ul>
	<ul style="list-style-type: none"> <li>■ Display active power, reactive power and apparent power information of the selected system type.</li> <li>■ Down page or reduce value</li> </ul>	<ul style="list-style-type: none"> <li>■ Running hours</li> <li>■ Modbus ID</li> <li>■ Baud rate</li> <li>■ Parity</li> <li>■ Identification code</li> <li>■ Full screen</li> </ul>
	<ul style="list-style-type: none"> <li>■ Display total / import / export active or reactive energy information of the selected system type.</li> <li>■ Right side move</li> </ul>	<ul style="list-style-type: none"> <li>■ Set-up mode entry</li> <li>■ Confirmation</li> </ul>

## 3.2 Display Mode Screen Sequence

Click button	3 Phase 4 Wire		3 Phase 3 Wire		1 Phase 2 Wire	
	Screen	Parameters	Screen	Parameters	Screen	Parameters
	1	Phase 1 – Power Voltage Current kWh	1	Phase 1 – Power Voltage Current kWh	1	Phase 1 – Power Voltage Current kWh
	2	Phase 2 – Power Voltage Current kWh	2	Phase 2 – Power Voltage Current kWh		
	3	Phase 3 – Power Voltage Current kWh	3	Phase 3 – Power Voltage Current kWh		
	4	Phase 1 – Power Voltage Current kVarh	4	Phase 1 – Power Voltage Current kVarh	2	Phase 1 – Power Voltage Current kVarh
	5	Phase 2 – Power Voltage Current kVarh	5	Phase 2 – Power Voltage Current kVarh		
	6	Phase 3 – Power Voltage Current kVarh	6	Phase 3 – Power Voltage Current kVarh		
	1	Voltage L1-N Voltage L2-N Voltage L3-N			1	Voltage L1-N
	2	Voltage L1-L2 Voltage L2-L3 Voltage L3-L1	1	Voltage L1-L2 Voltage L2-L3 Voltage L3-L1		
	3	Current L1 Current L2 Current L3 Current Neutral	2	Current L1 Current L2 Current L3	2	Current L1
	4	THD% of Voltage L1 THD% of Voltage L2 THD% of Voltage L3	3	THD% of Voltage L1-2 THD% of Voltage L2-3 THD% of Voltage L3-1	3	THD% of Voltage L1
	5	THD% of Current L1 THD% of Current L2 THD% of Current L3	4	THD% of Current L1 THD% of Current L2 THD% of Current L3	4	THD% of Current L1
	6	Phase Sequence	5	Phase Sequence		

Click button	3 Phase 4 Wire		3 Phase 3 Wire		1 Phase 2 Wire	
	Screen	Parameters	Screen	Parameters	Screen	Parameters
	1	Total Power Factor Frequency	1	Total Power Factor Frequency	1	Total Power Factor Frequency
	2	PF L1 PF L2 PF L3	2	PF L1 PF L2 PF L3		
	3	Max. DMD of Current L1 Max. DMD of Current L2 Max. DMD of Current L3	3	Max. DMD of Current L1 Max. DMD of Current L2 Max. DMD of Current L3	2	Max. DMD of Current L1
	4	Max. DMD of W Max. DMD of Var Max. DMD of VA	4	Max. DMD of W Max. DMD of Var Max. DMD of VA	3	L1 Max. DMD of W L1 Max. DMD of Var L1 Max. DMD of VA
	5	Max. Voltage of L1 Max. Voltage of L2 Max. Voltage of L3	5	Max. Voltage of L1-2 Max. Voltage of L2-3 Max. Voltage of L3-1	4	Max. Voltage of L1
	6	Min. Voltage of L1 Min. Voltage of L2 Min. Voltage of L3	6	Min. Voltage of L1-2 Min. Voltage of L2-3 Min. Voltage of L3-1	5	Min. Voltage of L1
	7	Max. Current of L1 Max. Current of L2 Max. Current of L3 Max. Current of N	7	Max. Current of L1 Max. Current of L2 Max. Current of L3 Max. Current of N	6	Max. Current of L1
	8	Min. Current of L1 Min. Current of L2 Min. Current of L3 Min. Current of N	8	Min. Current of L1 Min. Current of L2 Min. Current of L3 Min. Current of N	7.	Min. Current of L1
	1	Active Power L1 Active Power L2 Active Power L3	1	Active Power L1 Active Power L2 Active Power L3		
	2	Reactive Power L1 Reactive Power L2 Reactive Power L3	2	Reactive Power L1 Reactive Power L2 Reactive Power L3		
	3	Apparent Power L1 Apparent Power L2 Apparent Power L3	3	Apparent Power L1 Apparent Power L2 Apparent Power L3		
	4	Total Active Power Total Reactive Power Total Apparent Power	4	Total Active Power Total Reactive Power Total Apparent Power	1	L1 Active Power L1 Reactive Power L1 Apparent Power
	1	Total kWh	1	Total kWh	1	Total kWh
	2	Total kVarh	2	Total kVarh	2	Total kVarh
	3	Import kWh	3	Import kWh	3	Import kWh
	4	Export kWh	4	Export kWh	4	Export kWh
	5	Import kVarh	5	Import kVarh	5	Import kVarh
	6	Export KVarh	6	Export KVarh	6	Export KVarh

### 3.3 Individual Harmonic Distortion:



Press the button  for 3 seconds to check Harmonic distortion of voltage

2~63rd Harmonic distortion of voltage



Press the button  for 3 seconds to check Harmonic distortion of current

2~63rd Harmonic distortion of current

## 4. Display information

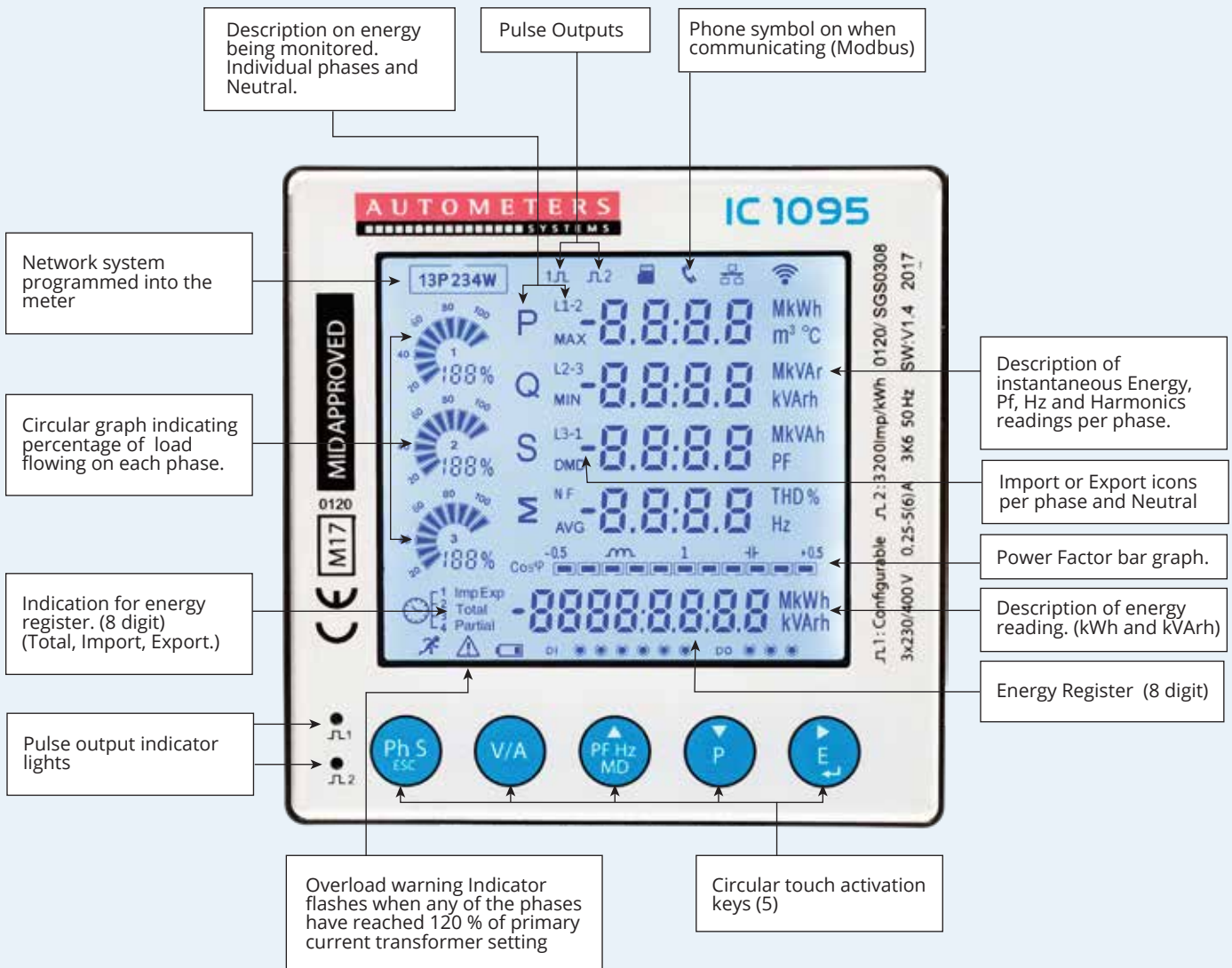

# 5. Programming the meter

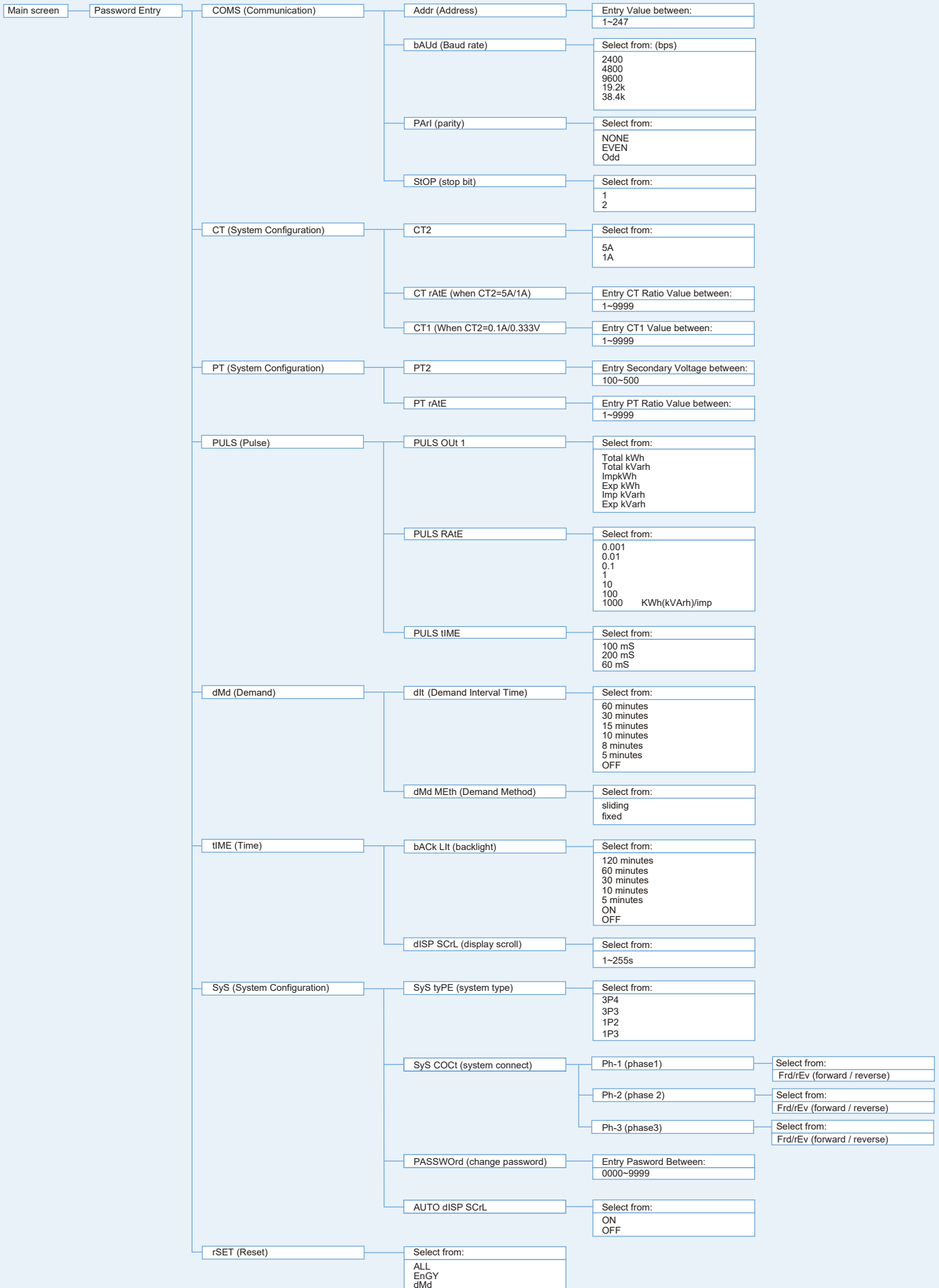



## 5.1 Password Entry



Setting-up mode is password protected, so you must enter the correct password.

By firmly pressing the button  for 3 seconds, the password screen appears.

The default password is 1000.

If an incorrect password is entered, the display shows ERR.

## 5.2 Communication

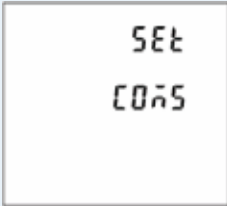

The RS485 port can be used for communications using Modbus RTU protocol. Parameters such as Address, Baud rate, Parity, Stop bit can be selected.

Long press  to enter the Address option.

### 5.2.1 Communication status



Indication only

### 5.2.2 Address





An RS485 network can accommodate up to 255 different devices, each identified by an individual address.

The Modbus address range on the IC 1095 is between 001~247

Default setting from Autometers is 001

Long press  to enter the selection routine.

The address setting will flash. Use  and  to increment or reduce the number.



Long press  for confirmation.

### 5.2.3 Baud rate



Baud rate options: 2400 4800 9600 19200 38400 (bps).

Default: 9600bps

From the Set-up menu, Use  and  to select the Baud rate options.

Long press  to enter the selection routine.

The Baud Rate setting will flash. Use  and  to choose Baud Rate.

And long press  for confirmation

### 5.2.4 Parity



Parity Options: NONE, EVEN, ODD.

Default Parity : EVEN

Note that if parity is set to ODD or EVEN, Stop Bits will be set to 1 and cannot be changed.

From the Set-up menu, Use and to select the Parity options.

Long Press to enter the selection routine.

The Parity setting will flash. Use and to choose Parity.

Example shows:

Set Parity: EVEN

And long press for confirmation.

Press to return the main set up menu.



### 5.3 C.T. (Current Transformer)

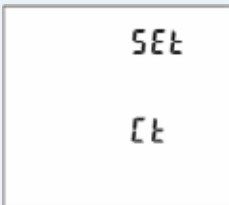

From the main Set-up menu, Use and to select the CT option.

#### 5.3.1 C.T.2 (Current Transformer)

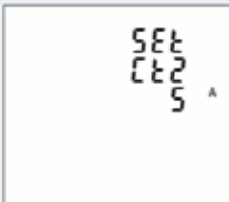

Set C.T.2 secondary current input.

Options: 5A or 1A

Default CT2: 5A

Long press to enter the CT2 routine.

Press for 3s, the CT2 setting will flash.

Use and to choose CT2 with 5A or 1A.

#### 5.3.2 C.T. Rate (Current Transformer)



To set the primary current ratio in the meter you must program the divider into the meter. e.g. to set 200/5 amp input "0040" (Divide the primary by 5) 5 amp being the secondary of the c.t. see section 4.3.3 for the table.

Options: 1~2000

Default CT rate 1. ( New Ratio Must Be Programmed Into The Meter)

Long press to enter the CT Rate routine.

Press for 3s, the CT rate setting will flash.

Use and to choose CT rate with 1~2000.

And long press for confirmation

### 5.3.3. Example of meter set at 200/5 amp



Example of how the display should look for a meter programmed to 200/5 amp. See table for more settings.

C.T Primary	Number to program into the meter	C.T Primary	Number to program into the meter
100/5	20	800/5	160
150/5	30	1000/5	200
200/5	40	1200/5	240
250/5	50	1500/5	300
300/5	60	1600/5	320
400/5	80	2000/5	400
500/5	100	2500/5	500
600/5	120	3000/5	600

### 5.4 P.T. (Voltage Supply)

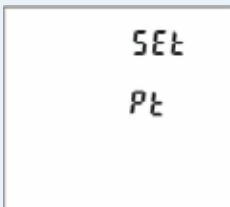

The meter has been designed to work in 3 phase 4 wire or a 3 phase 3 wire network and this requires a primary and secondary voltage ratio input. The default is a 3 phase 4 wire configuration.

Long press  to enter the PT2 routine.

For example:

A 3 phase 3 wire, 11000/110 Volt configuration:  
Set the secondary (P.T.2) to 110 and the "RATE" (P.T.1 multiplier) to 100.  
(110 X100 = 11,000)

#### 5.4.1 P.T.2 (voltage supply)

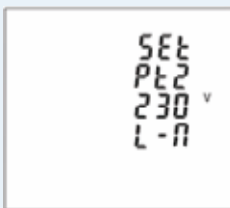

Set secondary voltage input the meter  
Range: 100V ~ 480V  
Default: 230V (L-N)

Long press  for confirmation.

#### 5.4.2 P.T.1. Rate (Primary Voltage)

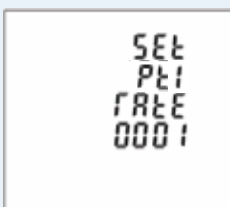



Set primary voltage input the meter  
Range: 1V ~ 2000V  
Default: 1

Then press  to enter the PT2 routine.

Press  for 3s, the PT2 setting will flash.

Use  or ,  to select PT2.

Long press  for confirmation.

Press  to return the PT set up menu.

## 5.5 Pulse

This option allows you to configure the pulse output. The output can be set to provide a pulse for a defined amount of energy active or reactive.

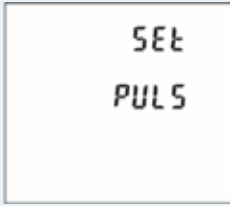

This option sets the pulse output type, pulse rate, duration time.

From the Set-up menu, Use  and  to select the Pulse option.

### 5.5.1 Pulse output1



Pulse output 1 setting

Output type options: Total kWh, Import kWh, Export kWh, Total kVarh, Import kVarh, Export kVarh.

Default: Total kWh

Long press  to enter the PT Pulse Output 1 routine.

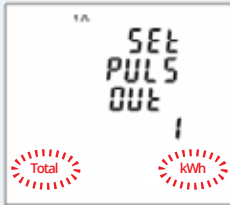



Example shows:

Pulse Output 1: Total kWh

Options: **Total kWh**, Total kVarh, Import, kWh Export kWh, Import kVarh, Export kVarh.

Press  for 3s, the setting will flash.



 and  to choose Options.

Long press  for confirmation.



### 5.5.2 Pulse rate



Pulse rate options: 0.001 , 0.01 , 0.1 , 1, 10, 100, 1000 kWh / kVarh per Pulse  
Default : 0.01 kWh (100imp/kWh)

Use  and  to select Pulse Rate option.

Long press  the setting will flash.

Use  and  to choose Options.

Long press  for confirmation.



Example shows:

Pulse rate: 0.01

### 5.5.3 Pulse Duration



Pulse Duration time option 200, 100, 60mS  
Default : 100mS

Use and to enter Pulse duration routine.

Long press , the setting will flash. Use and to choose Options.

And long press for confirmation.

Press to return the Pulse Duration set up menu.

### 5.6 Demand

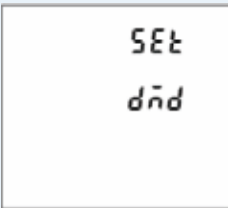

This sets the period in minutes over which the current and power readings are integrated for maximum demand measurement. The options are: OFF, 5, 8, 10, 15, 30 and 60 minutes.

From the Set-up menu, Use and to select the Demand option.

#### 5.6.1 Demand interval time



The screen will show the currently selected interval time. Default is 30

Long press to enter the DIT routine.

Press for 3s, the setting will flash.

Use and to choose Options.

Long press for confirmation.

#### 5.6.2 Demand method



The screen shows the Demand calculation method: Fixed interval time or Sliding window.

Use and to enter Demand calculation method.



Long press to enter the routine.

The setting will flash. Use and to choose Options.

And long press for confirmation.

Press to return the Demand set up menu.

## 5.7 Back light display time setting.

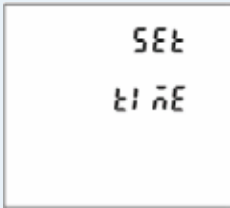

This option sets the backlight on time and display scroll time.

From the Set-up menu, Use and to select the Time option.

### 5.7.1 Backlight time



The meter provides a function to set the time the back light is on.

Options: ON/OFF/5/10/30/60/120 minutes. Default: 60

Note: if it is set as ON, the backlit will always be on.

Long press to enter the Backlit time routine.

Press for 3s, the setting will flash.

Use and to choose Options.

And long press for confirmation.

### 5.7.2 Display Scroll time

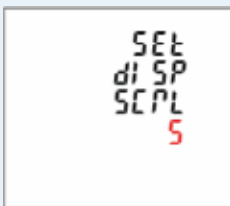

The meter provides a function to set the Display scroll time.

Options: 1~255s. Default: 5

Use and to select Display scroll time option.

Press for 3s, the setting will flash.

Use and to choose Options.

And Long press for confirmation.

Press to return the Time set up menu.

## 5.8 System (Network Connection)

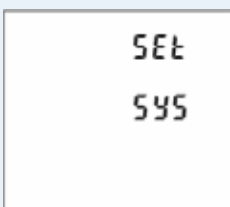

The meter provides a function to set the Network connection.

Use this section to set the type of electrical system required.

Options: 3P4W (Default setting), 3P3W, 1P2W

From the Set-up menu, Use and to select the System option.

### 5.8.1 System Network

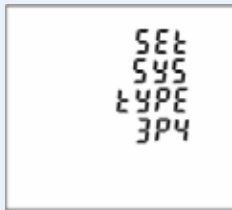

The screen shows the currently selected power supply is three phase four wire

Long press to enter the System type routine.

Press for 3s, the setting will flash. Use and to choose Options.

And Long press for confirmation.



Example:

The screen shows the meter is currently set up to monitor a three phase three wire network.

### 5.8.2 System Connect (C.T correction)

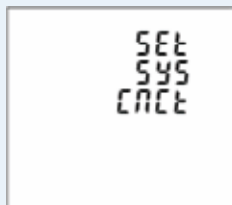

This meter provides a function where you can adjust the current transformer connection internally via the front keys. Each phase can be altered.

Use and to select the correction option.



Options: Frd ( forward ) and rEv ( reverse)

Long press to enter the Phase 1 correction.

Press for 3s, the setting will flash.

Use and to choose Options.

Long press for confirmation.

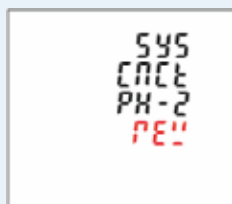

Press enter Phase 2 correction.

Press for 3s, the setting will flash.

Use and to choose Options.

Long press for confirmation.

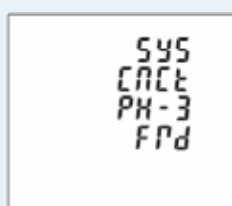

Press enter Phase 3 correction.

Press for 2s, the setting will flash.



Use and to choose Options.

Long press for confirmation. Press to return the System set up menu.

### 5.8.3 Change password





This meter provides a function with password setting.  
Default: 1000  
Options: 0000~99999

Use  and  to select the change password option.



Press  for 3s, the setting will flash.

Use  or  to increment the number.



Press  to choose options.

Long press  for confirmation.



### 5.8.4 Automatic display scroll



This meter provides a function with automatic display scroll setting.  
Options: on and off  
There are two ways: First way.

Use  and  to select the automatic display scroll option.

Press  for 3s, the setting will flash.

Use  and  to choose options "On" or "Off".

Long press  for confirmation.

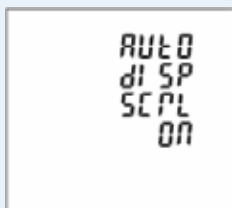

Second way  
Escape the Setting menu.

Long press  for 3 secs.

For example,  
The screen shows the currently selected Automatic Scroll display ON.  
To switch to off:

Long press  for 3 secs, then the screen shows the currently selected Automatic Scroll display OFF.



## 5.9 Parameter Reset

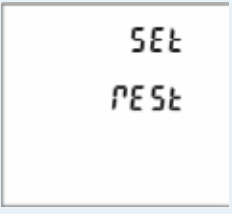

This unit provides a function with reset for Energy and Demand, and all parameters.

Use and to select the Reset option.



Long press to enter the Energy routine.

Press for 3s, the setting will flash.

Then long press to confirm the reset.

NOT  
AVAILABLE  
ON MID  
APPROVED  
METERS

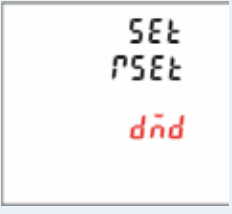

Then press enter Demand Reset routine.

Press for 3s, the setting will flash.

Long press to confirm the reset.



Then press enter ALL Reset routine.

Press for 3s, the setting will flash.

Then long press to confirm the reset.

Press to return the Reset set up menu.

NOT  
AVAILABLE  
ON MID  
APPROVED  
METERS

## 6. Specification

### 6.1 Measured Parameters

The unit can monitor and display the following parameters of a 1 phase 2 wire, 3-phase 3-wire or 3-phase 4-wire supply.

#### 6.1.1 Voltage and Current

Rated Voltage Input: 3x230/400V 50Hz  
 Installation Category III (600V)  
 Rated Current: 5A  
 Current input range: 5%~120% I<sub>b</sub>  
 Percentage total voltage harmony distortion (THD %) for each phase to N  
 Percentage current harmonic distortion for each phase  
 Current on each phase

#### 6.1.2 Power factor and Frequency and Maximum Demand

Frequency in Hz (45~66Hz)  
 Instantaneous power: Power 0 to 9999MW  
 Reactive Power: 0 to 9999MVAR  
 Volt-amps: 0 to 9999 MVA  
 Maximum demanded power from last reset.  
 Maximum demand current, from last reset (three phase supplies only)

#### 6.1.3 Energy Measurements

Imported active energy..... 0 to 99999999.9 kWh  
 Exported active energy..... 0 to 99999999.9 kWh  
 Imported reactive energy..... 0 to 99999999.9 kVArh  
 Exported reactive energy..... 0 to 99999999.9 kVArh  
 Total active energy..... 0 to 99999999.9 kWh  
 Total reactive energy..... 0 to 99999999.9 kVArh

### 6.2 Accuracy

- Voltage VL-N..... 0.5%
- Voltage VL-L..... 0.5%
- Current..... 0.5%
- Frequency..... 0.1
- Active power..... 0.5%
- Apparent power..... 0.5%
- Reactive power..... 1%
- Power factor..... 0.01
- Active energy..... EN50470-1/-3 Class C and Class B IEC62053-21 Cl.1 or IEC62053-22 Cl.0.5S
- Reactive energy..... IEC62053-23 CL.2
- THD..... 1%

### 6.3 Display

- Liquid crystal display with backlit (360° Full viewing angles)
- 4 lines, 4 digits per line to show electrical parameters
- 5th line, 8 digits to show energy
- Bar graph for power indication
- Display update time: 1 sec. for all parameters
- Display scrolling: automatic or manual (Programmable)

### 6.4.1 Pulse Output

The pulse outputs can be set to generate pulses to represent kWh/kVarh  
 Pulse constant: 0.001/0.01/0.1/1/10/100/1000 kWh or kVarh per Pulse  
 Pulse width: 200/100/60 Ms.  
 The pulse output is passive type, complies with IEC62053-31 Class A.

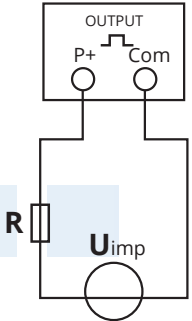

ATTENTION: Pulse output must be fed as shown in the wiring diagram below. Scrupulously respect polarities and the connection mode. Opto-coupler with potential-free SPST-No Contact.  
 Contact range: 5~27VDC Max. current Input: 27mADC

### 6.4.2 Modbus RTU

Interface standard and protocol: RS485 and MODBUS RTU  
 Communication address: 1~247  
 Transmission mode: Half duplex  
 Data type: Floating point  
 Transmission distance: 1000m Maximum  
 Transmission speed: 2400bps~38400bps  
 Parity: None, Odd, Even  
 Stop bits: 1 or 2  
 Response time: <100 MS

For Modbus RTU, the following RS485 communication parameters can be configured from the Set-up menu:

- Baud rate** 2400, 4800, 9600, 19200, 38400
- Parity** none/odd/even
- Stop bits** 1 or 2
- RS485 network address** – 3-digit number, 001 to 247

**Autometers Default Setting:**

- Baud rate: 9600
- Parity: Even
- Stop bits: 1
- FT: High word first

### 6.4.3 Environment

Operating temperature.....	-25°C to +55°C
Storage temperature.....	-40°C to +70°C
Relative humidity.....	0 to 95%, non-condensing
Altitude.....	<2000 meters
Vibration.....	10Hz to 50Hz, IEC 60068-2-6, 2g
Pollution degree.....	II
Protection against dust and water...	IP51(indoor)
Mechanical environment.....	M1
EMC environment.....	E1

### 6.4.4 Dimensions and Material

The meter is a 96 x 96 mm panel mounted meter with a depth of 70mm  
 The cut out hole for the panel meter is 92 x 92 mm.

- Manufactured in Self-extinguishing UL 94 V-0

## 7. Maintenance

In normal use, little maintenance is needed. As appropriate for service conditions, isolate electrical power, inspect the unit and remove any dust or other foreign material present. Periodically check all connections for freedom from corrosion and screw tightness, particularly if vibration is present.

The front of the case should be wiped with a dry cloth only. Use minimal pressure, especially over the viewing window area. If necessary wipe the rear case with a dry cloth. If a cleaning agent is necessary, isopropyl alcohol is the only recommended agent and should be used sparingly. Water should not be used. If the rear case exterior or terminals should be contaminated accidentally with water, the unit must be returned to Autometers Systems Ltd for inspection and testing.

## 8. Installation

The meter may be mounted in a panel with a maximum thickness of 3 mm. Leave enough space behind the instrument to allow for bends in the connection cables. The unit is intended for use in a reasonably stable ambient temperature within the range  $-25^{\circ}\text{C}$  to  $+55^{\circ}\text{C}$ . Do not fit the meter where there is excessive vibration or in excessive direct sunlight.

*Please note terminal covers should be fitted and sealed.*

*See connection diagram page 21, 22.*

### 8.1 Safety

The unit is designed in accordance with IEC 61010-1:2010 – Permanently connected use, Normal condition. Installation category III, pollution degree 2, basic insulation for rated voltage.

## 9. Electrician.

The IC 1095 panel meter should only be installed by a fully qualified electrician who has knowledge of electricity meters connected with current transformers.

It is the installer who is fully responsible for the safe installation of this meter. It must be installed to meet the current electrical regulations concerning installation of panel meters.

## 10. EMC Installation Requirements

Whilst this unit complies with all relevant EU EMC (electro-magnetic compatibility) regulations, any additional precautions necessary to provide proper operation of this and adjacent equipment will be installation dependent and so the following can only be general guidance: Avoid routing wiring to this unit alongside cables and products that are, or could be, a source of interference.

The auxiliary supply to the unit should not be subject to excessive interference. In some cases, a supply line filter may be required.

To protect the product against incorrect operation or permanent damage, surge transients must be controlled. It is good EMC practice to suppress transients and surges at the source. The unit has been designed to automatically recover from typical transients; however in extreme circumstances it may be necessary to temporarily disconnect the auxiliary supply for a period of greater than 10 seconds to restore correct operation.

Screened communication leads are recommended and may be required. These and other connecting leads may require the fitting of RF suppression components, such as ferrite absorbers, line filters etc., if RF fields cause problems.

It is good practice to install sensitive electronic instruments that are performing critical functions in EMC enclosures that protect against electrical interference causing a disturbance in function.



## WARNING

- During normal operation, voltages hazardous to life may be present at some of the terminals of this unit. Installation and servicing should be performed only by qualified, properly trained personnel abiding by local regulations. Ensure all supplies are de-energized before attempting connection or other procedures.
- Terminals should not be user accessible after installation and external installation provisions must be sufficient to prevent hazards under fault conditions.
- This unit is not intended to function as part of a system providing the sole means of fault protection - good engineering practice dictates that any critical function be protected by at least two independent and diverse means.
- The unit does not have internal fuses therefore external fuses must be used for protection and safety under fault conditions.
- Never open-circuit the secondary winding of an energized current transformer.
- This product should only be operated with CT secondary connections Earthed.
- If this equipment is used in a manner not specified by the manufacturer, protection provided by the equipment may be impaired.

Auxiliary circuits (communication & relay outputs) are separated from metering inputs and 110-400V auxiliary circuits by at least basic insulation. Such auxiliary circuit terminals are only suitable for connection to equipment which has no user accessible live parts. The insulation for such auxiliary circuits must be rated for the highest voltage connected to the instrument and suitable for single fault condition. The connection at the remote end of such auxiliary circuits should not be accessible in normal use. Depending on application, equipment connected to auxiliary circuits may vary widely.

## II. Dimensions

The meter is a 96 x 96 mm panel mounted meter with a depth of 70mm  
The cut out hole for the panel meter is 92 x 92 mm.



# 12. Wiring Diagram

It is imperative that the current transformers are of the correct accuracy, fitted correctly and the meter is programmed to match the current transformers ratio.

## 3 phase 4 wire

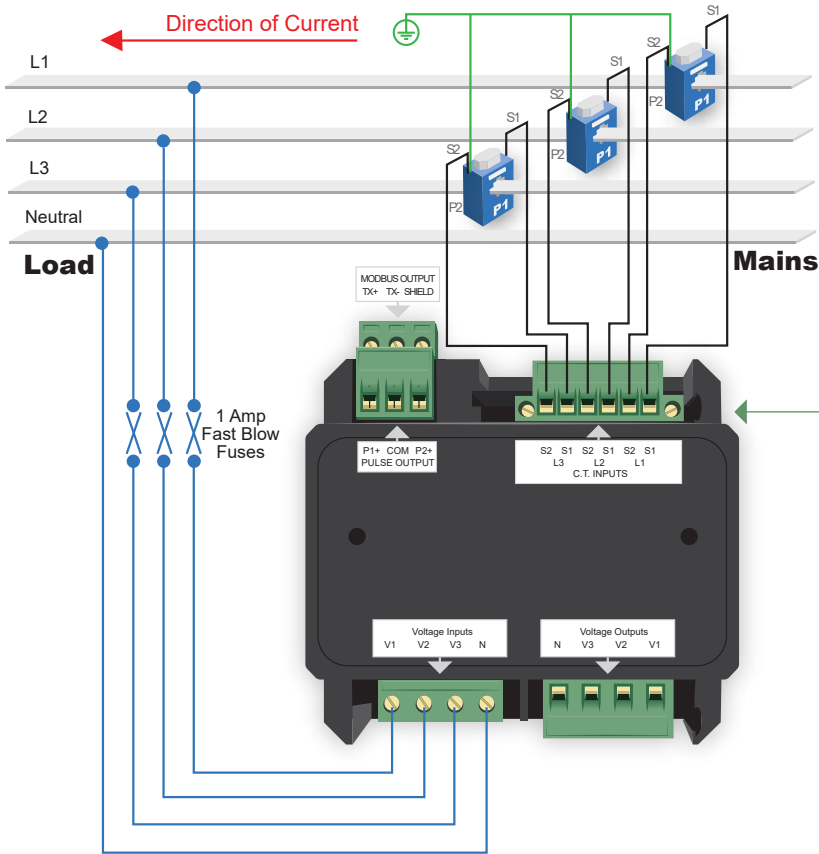

The back of the meter shows the green connections where the cables must be wired into, each separate green connector is a plug and socket.

The plugs can be removed by simply pulling them out of the socket.

The current transformer plug has retaining screws so it can not be pulled out by mistake. This must always be screwed in when complete.

Under no circumstances can any of the green plugs be pulled out when there is power on the meter.

Never leave a current transformer open circuit.

## 3 phase 3 wire

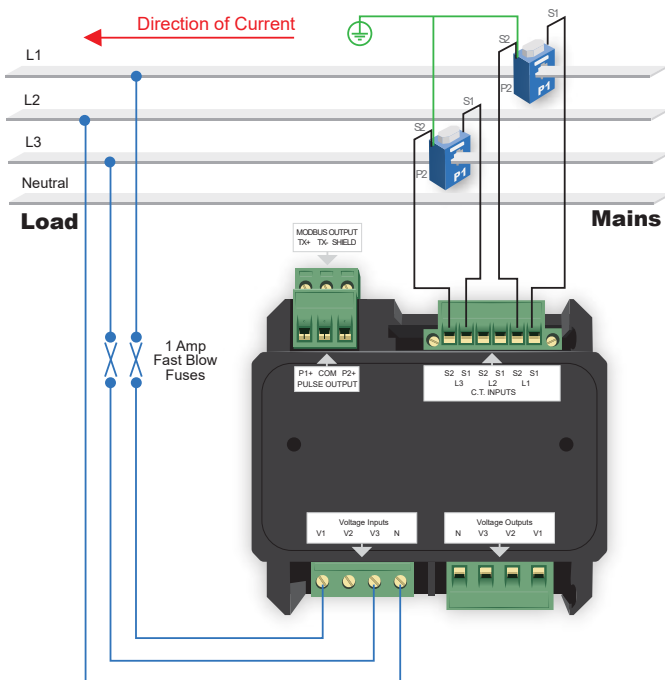

## 1 phase 2 wire

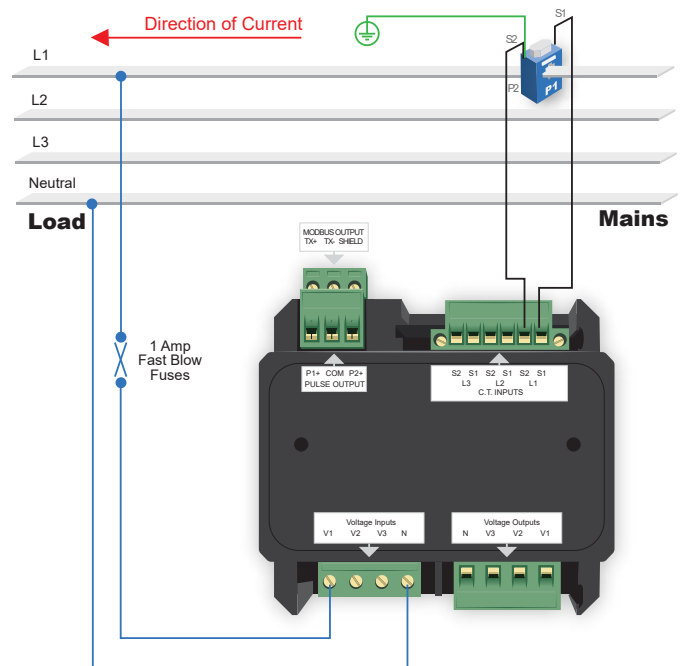

# 13. Quick Connect Connection Diagram

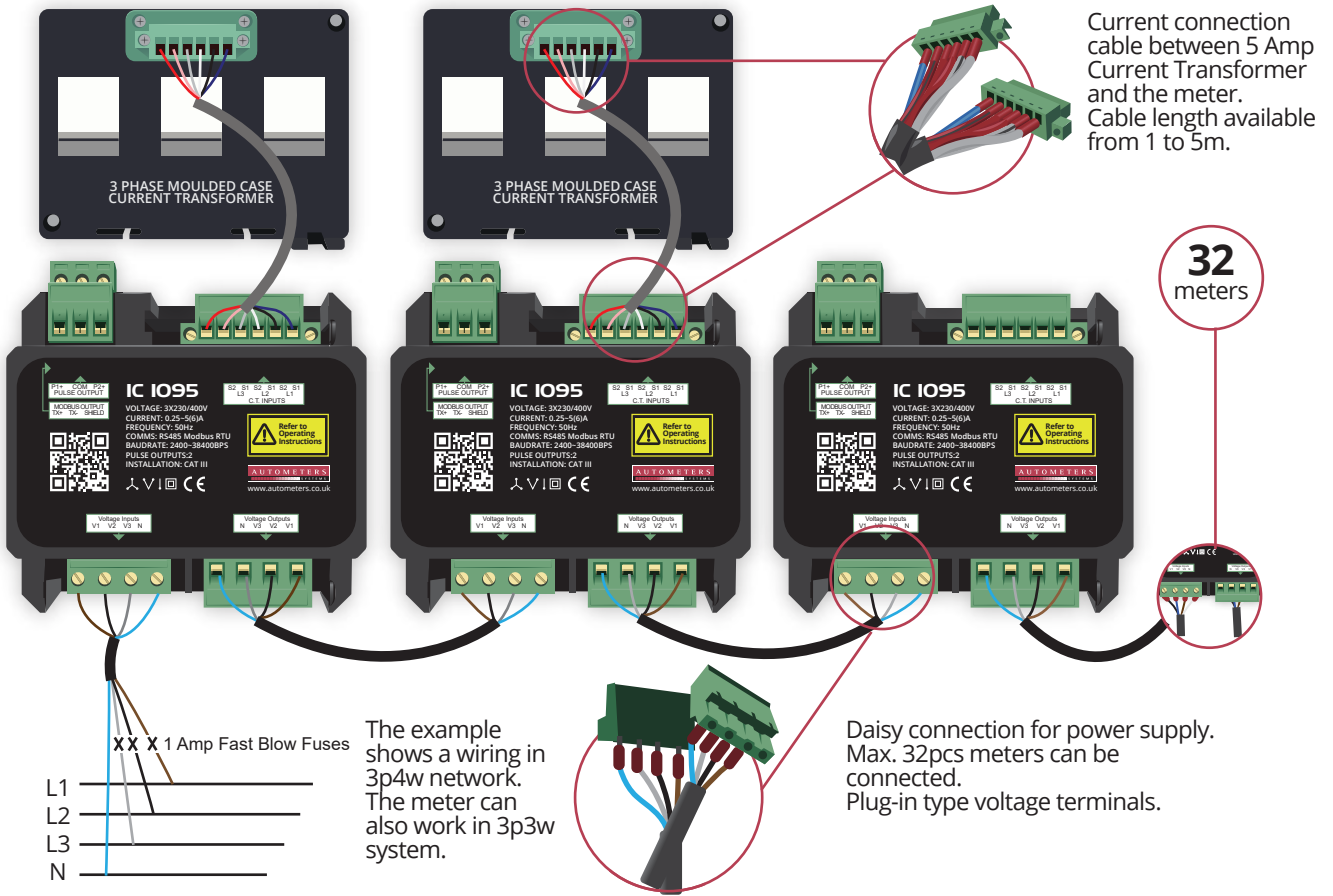

## 13.1 Sealing Points

Picture showing sealing points for the IC 1095 meter.

Seals must be fitted at these points to fully comply to the MID specifications.

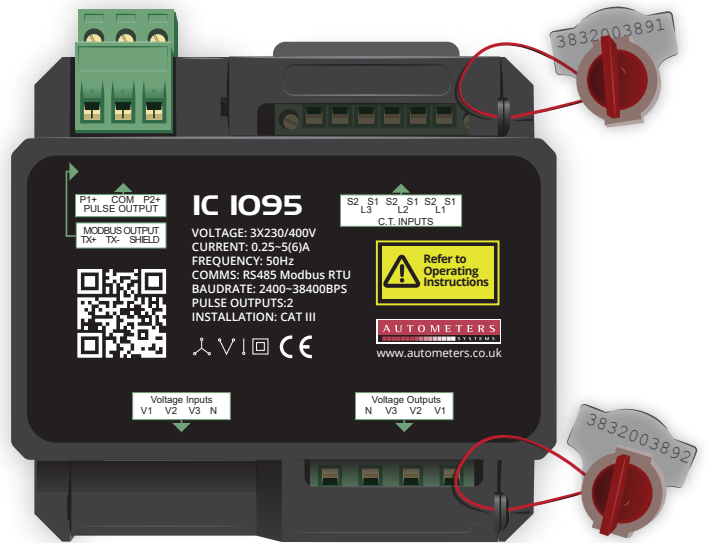

## Declaration of Conformity for the IC 1095 Panel Meter.

We, Autometers Systems Ltd, declare under our sole responsibility as the manufacturer of the Information Centre 1095 that the three phase four wire multifunction electrical energy meter "IC 1095" series correspond to the production model described in the EU-type examination certificate and to the requirements of the directive 2014/32/EU type examination certificate number 0120/SGS0308. Identification number of the NB0120.

# The Horizon Energy Monitoring System With the New IC 1095

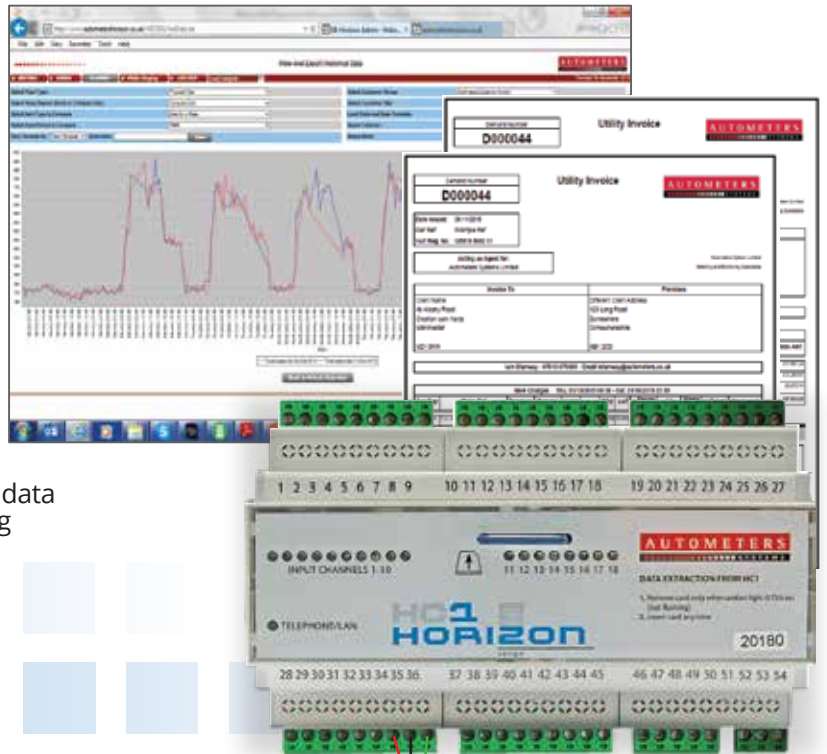

RS 485 Modbus Communication to enable full data retrieval of kWh for Graphic analysis and Billing

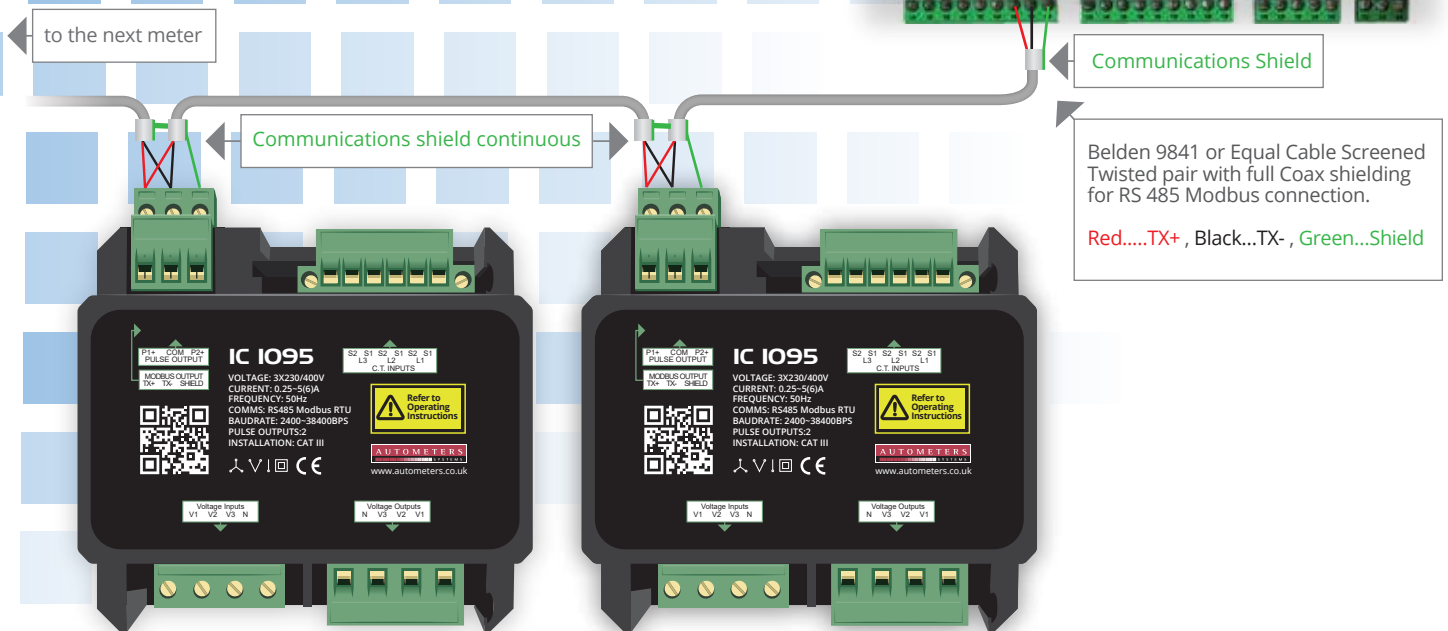

**Autometers Systems Ltd.**  
4B Albany Road, Chorlton-cum-Hardy  
Manchester M21 0AW  
Email: [sales@autometers.co.uk](mailto:sales@autometers.co.uk)  
Phone: 00(44) 0161 861 9056  
Fax: 0161 881 3745  
[www.autometers.co.uk](http://www.autometers.co.uk)

Product development is continuous and Autometers Systems Limited reserves the right to make alterations and manufacture without notice. Products as delivered may therefore differ from the descriptions and illustrations in this publication

