

AUTOMETERS

SYSTEMS

✓ **Easy-Wire Plug-in CT Connection**

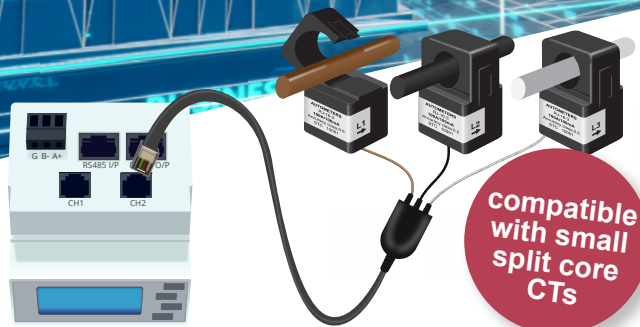

✓ **Four meters in one**
Connects up to four individual current transformer supplies in just one meter



✓ **Available in metal enclosures**



**NEW
EASY-WIRE
RANGE**

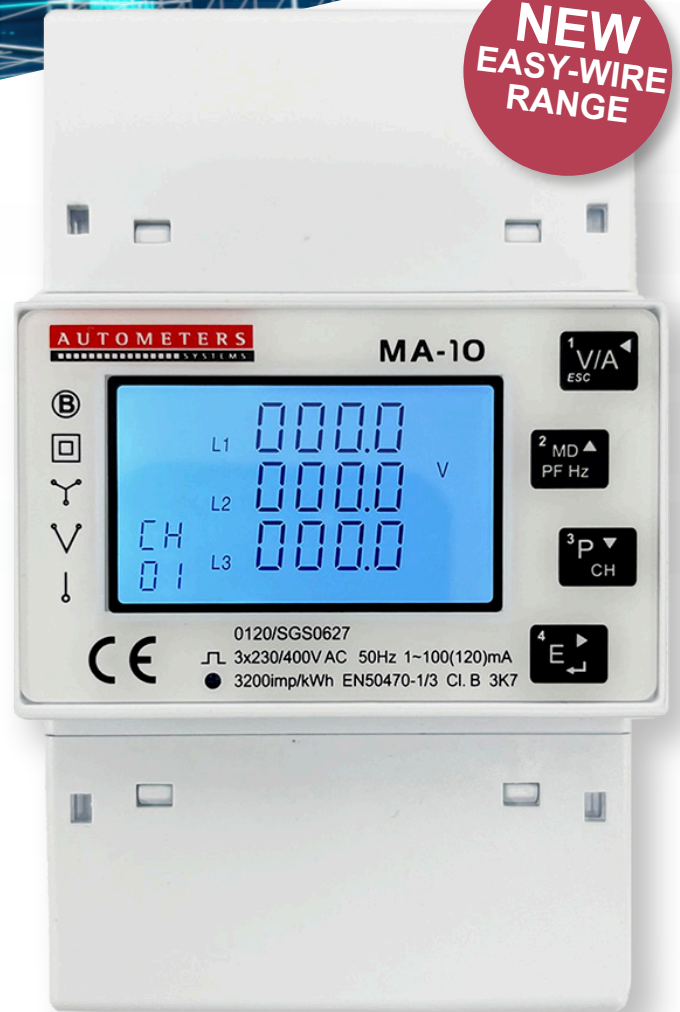

AUTOMETERS
SYSTEMS

MA-10

ⓑ
□
Y
V
I

L1 0000.0
L2 0000.0 V
L3 0000.0
CH 01

1 V/A ESC
2 MD PF Hz
3 P CH
4 E

0120/SGS0627
3x230/400V AC 50Hz 1~100(120)mA
3200imp/kWh EN50470-1/3 Cl. B 3K7

HORIZON
Energy Monitoring and Invoicing

HORIZON SYSTEM METER MA-10
Multi Function , Multi Tariff , MID Approved. Autometers Modbus V6.

Introduction	1
1. Unit Characteristics	2
1.1 Unit Characteristics	
1.2 RS485 Serial Modbus RTU	
2. Start-up Screens	
2.1 Reading an 8 digit kWh register number	
3. Keys and Displays	3
3.1 Button Functions	
3.2 Voltage and Current and Harmonics.....	4
3.3 Frequency and Power Factor and Demand	
3.4 Power.....	5
3.5 Energy Measurements	
4. Set-up	6
4.1 Set-up Entry Methods	
4.1.1 Menu Option Selection	
4.1.2 Number Entry Procedure	
4.2 Communication.....	7
4.2.1 Modbus RS 485 Address	
4.2.2 Baud Rate	
4.2.3 Parity	
4.2.4 Set Stop Button.....	8
4.3 CT	
4.3.1 CT1	
4.3.2 CT2	
4.4 DIT Demand Integration Time	
4.5 Backlight Set-up.....	9
4.6 Supply System	
4.7 Maximum Demand Reset	
4.8 Change Password.....	10
5. Specification	11
5.1 Measured Parameters	
5.1.1 Voltage and Current	
5.1.2 Power Factor and Frequency and Maximum Demand	
5.1.3 Energy Measurements	
5.2 Measured Inputs	
5.3 Interfaces for External Monitoring	
5.3.1 RS485 Output for Modbus RTU	
5.4 Accuracy.....	12
5.5 Environment	
5.6 Mechanics	
6. Dimensions	
7. Maintenance	13
8. Installation	
8.1 Safety	
9. Electrician	
10. EMC Installation Requirements	14
11. Wiring Diagrams	
11.1 Voltage Connections	
11.2 Easy wire CT Connections.....	15
12. The Horizon Energy Monitoring System with the new MA-10 meter	16
12.1 Easy-wire Modbus Connection	
12.2 Hard Wired Modbus Setup.....	17
12.3 Hybrid Wiring Modbus Setup	
13. Metal Enclosures for the MA-10 meter	

Introduction

This document provides operating, maintenance and installation instructions. These units measure and display the characteristics of single phase two wires (1p2w), three phase three wires (3p3w) and three phase four wires (3p4w) networks. The measuring parameters include voltage (V), frequency (Hz), current (A), power (kW/kVa/kVar), import, export and total Energy (kWh/kVarh). The units can also measure Maximum demand current and power, this is measured over preset periods of up to 60 minutes.

This unit is a milliAmp current transformer operated meter and can be configured to work with a wide range of CTs. RS 485 Modbus RTU outputs. Configuration is password protected.

The new MA-10 meter is supplied with an RS 485 Modbus protocol.

The Modbus output is defaulted to work directly with the Horizon data monitoring and invoicing system

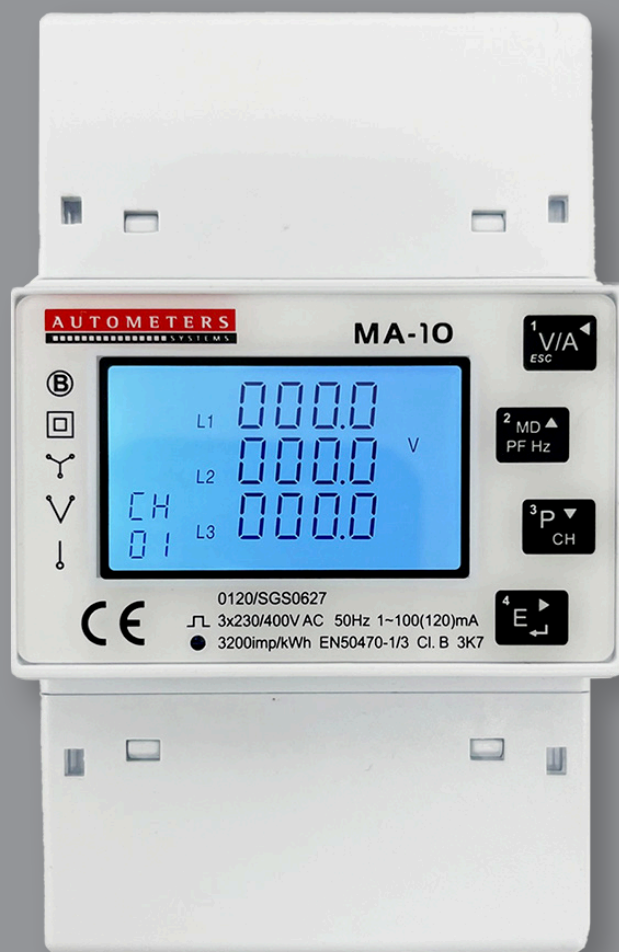

Declaration of Conformity

We Autometers Systems Ltd declare under our sole responsibility as the manufacturer that the poly phase multifunton electrical energy meter "MA-10 meter" correspond to the production model described in the EC-type examination certificate and to the requirements of the Directive 2014/32/EU EU Type examination certificate number 0120/SGS0627. Identification number of the NB0120

I. Unit Characteristics

1.1 Unit Characteristics





- MID Approved (SGS.UK) Appendix B and D
- Measures kWh, KVAh, KVar,PF,HZ, Max demand
- RS 485 Modbus (Autometers V6 protocol)
- BI- Directional Measurement for Import and Export
- Back light LCD for full viewing Angles
- Available as 1 Phase 2, Wire, 3 Phase 3 Wire and 3 Phase 4 Wire

An RS485 output allows remote monitoring from another display or a computer.

1.2 RS485 Serial-Modbus RTU

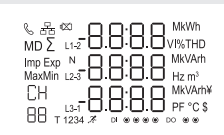
RS485 serial port with Mod bus RTU protocol to provide a means of remotely monitoring and controlling the Unit. Set-up screens are provided for setting up the RS485 port.

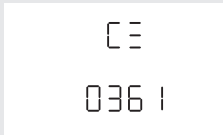
2. Start up screens

				
<p>The first screen lights all LED segments and can be used as a display LED check</p>	<p>The second screen indicates the software version of the unit. (the above picture is just for reference)</p>	<p>The unit performs a self-test and the screen indicates if the test is passed.</p>	<p>After a short delay, the screen will display active energy measurements.</p>	

2.1 Reading an 8 digit kWh register number



The top line shows the first four digits in the register number. The bottom line shows the next four digits.

In the example, the 8 digit kWh register number is 000003.14

3. Keys and Displays

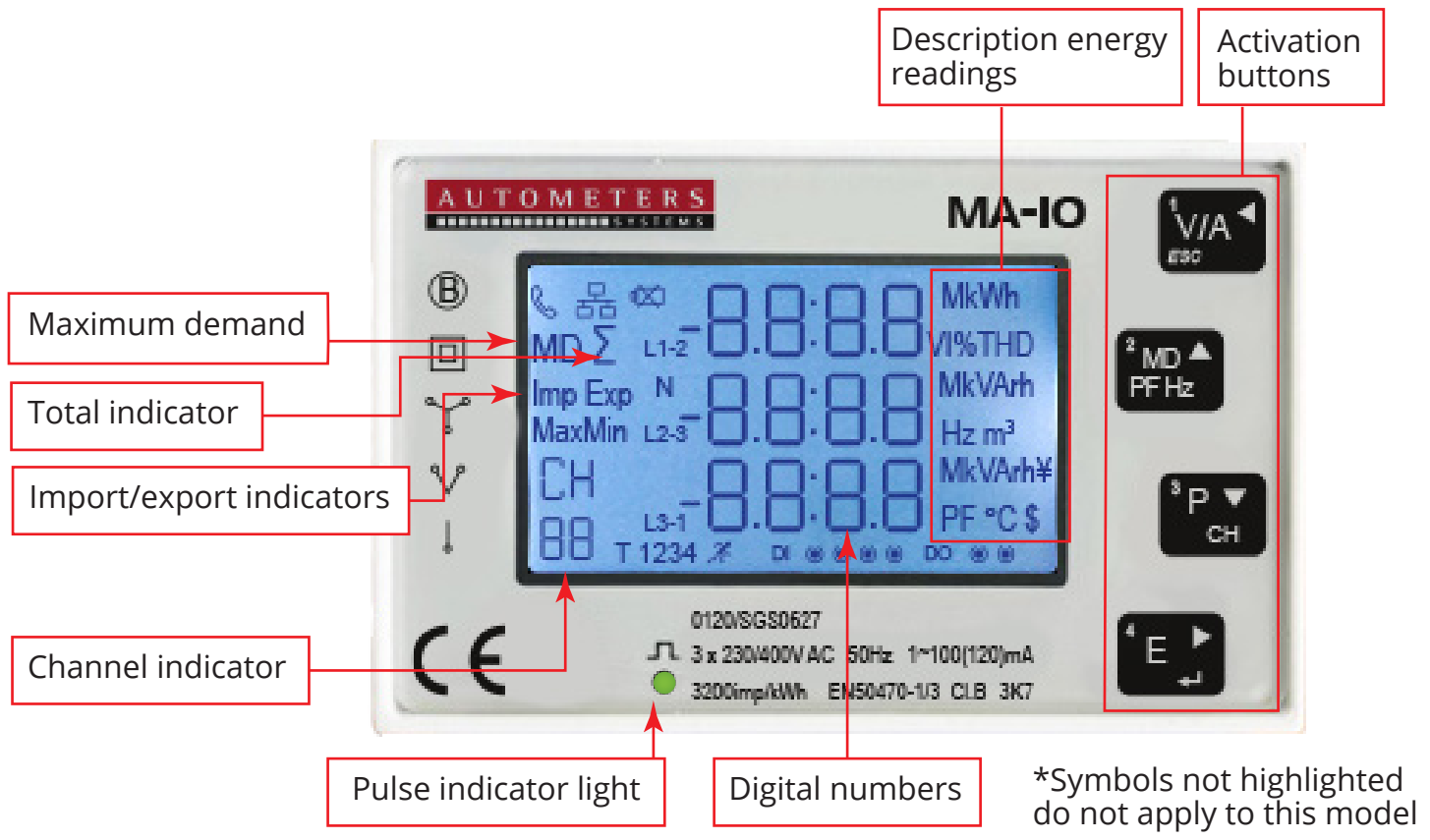

*Symbols not highlighted do not apply to this model

3.1 Button Functions

Button	Press
	<ul style="list-style-type: none"> Selects the Voltage and Current display screens. In Set-up Mode, this is the "Left" or "Back" button. Displays total harmonics, voltage and current on L1, L2, L3.
	<ul style="list-style-type: none"> Select the Frequency and Power factor display screens. In Set-up Mode, this is the "Up" button. Maximum demand of L1, L2, L3. Total maximum demand in kWh
	<ul style="list-style-type: none"> Select the Power display screens. In Set-up Mode, this is the "Down" button.
	<ul style="list-style-type: none"> Select the Energy display screens. In Set-up mode, this is the "Confirm", "Enter" or "Right" button.

3.2 Voltage, Current and Harmonics

Each successive press of the  button selects a new parameter:

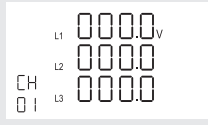

Phase to neutral voltages.

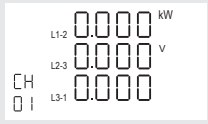

Phase to phase voltages.

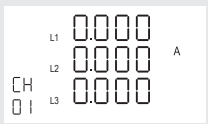

Current on each phase.



Neutral current.

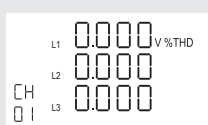

Total Voltage harmonics on L1, L2, L3.
Individual harmonics 2-19 available via Modbus.

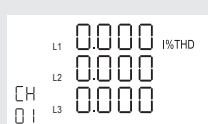

Total Current harmonics on L1, L2, L3.
Individual harmonics 2-19 available via Modbus.

3.3 Frequency and Power Factor and Demand

Each successive press of the  button selects a new range:

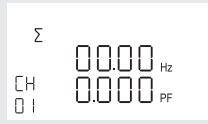

Total power factor and frequency.

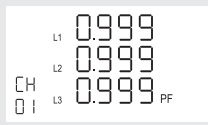

Power Factor of each phase.

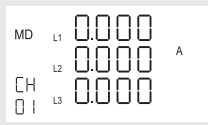

Maximum Current Demand.



Maximum Power Demand.

3.4 Power

Each successive press of the  button selects a new range:

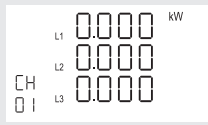

Instantaneous Active Power in kW.

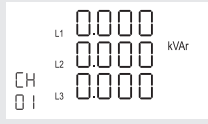

Instantaneous Reactive Power in kVAr.

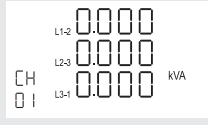

Instantaneous Volt-Amps in KVA.



Total kW, kVArh, kVA.

3.5 Energy Measurements

Each successive press of the  button selects a new range:



Total Imported active energy in kWh.



Total Imported reactive energy in kVArh.

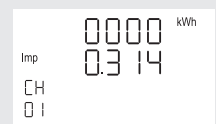

Imported active energy in kWh.



Exported active energy in kWh.

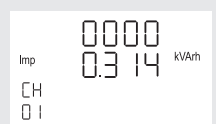

Imported reactive energy in kVArh.



Exported reactive energy in kVArh.

4. Set Up

To enter set-up mode, press the  button for 3 seconds until the password screen appears.

PASS

0000

Setting up is password-protected so you must enter the correct password (default '1000') before processing.

PASS

Err



If an incorrect password is entered, the display will show:
PASS Err

To exit set-up mode, press the  button repeatedly until the measurement screen is restored.



4.1 Set-up Entry Methods

Some menu items, such as password and CT, require a four-digit number entry while others, such as supply system, require selection from a number of menu options.



4.1.1 Menu Option Selection

Use the  and  buttons to scroll through the different options of the set-up menu.

Press  to confirm your selection.

If an item flashes, then it can be adjusted by the  and  buttons.



Having selected an option from the current layer, press  to confirm your selection. The SET indicator will appear.

Having completed a parameter setting, press  to return to a higher menu level. The SET indicator will be removed and you will be able to use the  and  buttons for further menu selection.

On completion of all setting-up, press  repeatedly until the measurement screen is restored.

4.1.2 Number Entry Procedure

When Setting up the unit, some screens require the entering of a number. In particular, on entry to the setting up section, a password must be entered. Digits are set individually, from left to right. The procedure is as follows:

The current digit to be set flashes and is set using the  and  buttons.

Press  to confirm each digit setting. The SET indicator appears after the last digit has been set.

After setting the last digit, press  to exit the number setting routine. The SET indicator will be removed.

4.2 Communication

Where the meter has been supplied with a RS 485 protocol output the individual parameters are set by using the front key panel.

4.2.1 Modbus RS 485 Address



Set Address now appears on the display.

Long press and the mod -bus address will be shown.



Long press again and first digit for the mod-bus address will flash.

Press the key to increment the number.



Press the key to move the cursor to the right.

When all three numbers have been selected long press to confirm, GOOD will appear to confirm locked.

Press to return to set address menu.

4.2.2 Baud Rate



From the set-up menu, use and buttons to select the Baud Rate option.

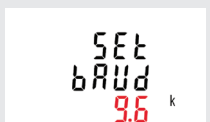

Press to enter the selection routine. The current setting will flash.



Use and buttons to choose Baud rate 1.2k, 2.4k, 4.8k, 9.6k, 19.2k, 38.4k

On completion of the entry procedure, press to confirm the setting and press to return to the main set up menu.

4.2.3 Parity



From the set-up menu, use and buttons to select the Parity option.



Press to enter the selection routine. The current setting will flash.



Use and buttons to choose parity (EVEN / ODD / NONE (default EVEN)).

On completion of the entry procedure, press to confirm the setting and press to return to the main set up menu.

4.2.4 Set Stop Button



Stop bit cannot be adjusted.

4.3 CT

From the set-up menu, use and buttons to select the CT option.

4.3.1 CT2



The CT2 is fixed at 100mA and cannot be adjusted.

4.3.2 CT1



To program the current ratio in the meter simply enter the primary current.
eg. if you require the meter to be set at 200amp program the numbers to be 0200.

Long press to enter the CT Rate routine. Press for 2s, the CT rate setting will flash.



Use and to choose the first digit of the CT value. Press to move the cursor to the right.

When you have entered the desired setting long press for confirmation

Press to change the channel (ch01-ch04) and repeat the above procedure for each channel.

Then press to return to the main menu.

4.4 DIT Demand Integration Time

This sets the period in minutes over which the current and power readings are integrated for maximum demand measurement. The options are: 0, 5, 8,10,15, 20, 30, 60 minutes.



From the set-up menu, use and buttons to select the DIT option. The screen will show the currently selected integration time.



Press to enter the selection routine. The current time interval will flash.



Use and buttons to select the time required.



Press to confirm the selection. SET indicator will appear.

Press to exit the DIT selection routine and return to the menu.

4.5 Backlight Set-up

The meter provides a function to set the blue backlight duration (0/5/10/30/60/120 minutes). Option 0 means the backlit always on here.



Default:60
If it's set to 5,the backlit will be off in 5minutes.



Use and buttons to choose the time
Press to confirm the setting and press to return to the main set up menu.

4.6 Supply System

The unit has a default setting of 3Phase 4wire (3P4). Use this section to set the type of electrical system.



From the set-up menu, use and buttons to select the system option. The screen will show the currently selected power supply.



Press to enter the selection routine. The current selection will flash.

Use and buttons to select the required system option:
1P2(W),3P3(W),3P4(W).



Press to confirm the selection. SET indicator will appear.

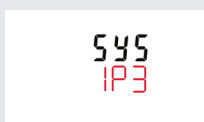

Press to change the channel (ch01-ch04) and repeat the above for each channel.

Press to exit the system selection routine and return to the menu. SET will disappear and you will be returned to the main set-up Menu.

4.7 Maximum Demand Reset

The meter provides a function to reset the maximum demand value of current and power.



Use and buttons to select the reset option.





Press to enter the selection routine. The dlt will flash

Press to confirm the setting and press to return to the main set up menu.

4.8 Change Password





Use  and  to choose the change password option.



Press the  button to enter the programming mode. The new password screen will appear with the first digit flashing.



Use  and  to set the first digit and press  to confirm your selection. The next digit will flash.



Repeat the procedure for the remaining three digits.



After setting the last digit SET will show.

Press  to exit the number setting routine and return to the set-up menu. SET will be removed.

5. Specification

5.1 Measured Parameters

The unit can monitor and display the following parameters of a single phase two wire(1p2w), three phase three wire(3p3w) or four phase four wire(3p4w) system.

5.1.1 Voltage and Current

Phase to neutral voltages 100 to 276V a.c. (not for 3p3w supplies).
 Voltages between phases 173 to 480V a.c.
 Percentage total voltage harmonic distortion (THD%) for each phase to N (not for 3p3w supplies).
 Percentage voltage THD% between phases (three phase supplies only).
 Current THD% for each phase

5.1.2 Power factor and Frequency and Maximum Demand

Frequency in Hz
 Instantaneous power:
 Power 0 to 96000 W
 Reactive power 0 to 96000 VAR
 Volt-amps 0 to 96000 VA
 Maximum demanded power since last Demand reset Power factor
 Maximum neutral demand current, since the last Demand reset (for three phase supplies only)

5.1.3 Energy Measurements

Imported/Exported active energy.....	0 to 9999999.9 kWh
Imported/Exported reactive energy.....	0 to 9999999.9 kVARh
Total active energy.....	0 to 9999999.9 kWh
Total reactive energy.....	0 to 9999999.9 kVARh

5.2 Measured Inputs

2 Voltage inputs through 4-way fixed connector with 2.5mm² stranded wire capacity. single phase two wire (1 p2w), three phase three wire (3p3w) or three phase four wire (3p4w) unbalanced. Line frequency measured from L 1 voltage or L3 voltage.

5.3 Interfaces for External Monitoring

Three interfaces are provided:

- RS 485 communication channel that can be programmed for Modbus RTU protocol

The Modbus configuration (baud rate etc.) and the pulse relay output assignments (kW/kVARh, import/export etc.) are configured through the set-up screens.

5.3.1 RS485 Output for Modbus RTU

For Modbus RTU, the following RS485 communication parameters can be configured from the set-up menu:

Baud rate 1200, 2400, 4800, 9600, 19200, 38400
 Parity none / odd / even
 Stop bits 1 or 2
 RS485 network address nnn - 3-digit number, 001 to 247

Please contact us if your require the Modbus/Mbus protocol document.

5.4 Accuracy

- Voltage 0.5%
- Current..... 0.5%
- Frequency..... 0.2%
- Power factor..... 1%
- Active power (W)..... 1%
- Reactive power (VAr)..... 1%
- Apparent power (VA)..... 1%
- Active energy (Wh)..... Class 1
- Reactive energy (VARh)..... Class 2

5.5 Environment

- Operating humidity..... ≤90%
- Storage humidity..... ≤95%
- Operating temperature..... -25°C to +55°C*
- Storage temperature..... -40°C to +70°C*
- International standard..... GB-T 17215/IEC62053-21/EN50470-1/3
- Accuracy class..... Class 1
- Installation category..... Cat III
- Protection against penetration of dust and water..... IP51 (indoor)
- Insulating encased meter of protective class..... II
- Max tightening torque..... 0.4Nm
- Altitude..... ≤2000m

* Maximum operating and storage temperatures are in the context of typical daily and seasonal variation.

5.6 Mechanics

- DIN rail dimensions..... 71.7 x 122.5 mm (WxH)
- Mounting..... DIN rail 35mm
- Sealing..... IP51 (indoor)
- Material..... Self-extinguishing UI94 V-0

6. Dimensions

The meter is a four module DIN rail mounted meter. Dimensions are 71.7mm width x 122.5mm height x 66mm deep

The cut out hole for the front of the enclosure is 72mm x 46mm

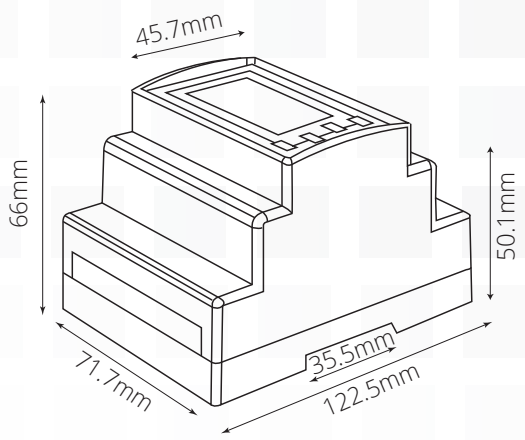

WARNING

Important Safety Information is contained in sections 7-8. Familiarize yourself with this information before attempting installation or other procedures. Symbols used in this document:

Risk of Danger: These instructions contain important safety information. Read them before starting installation or servicing of the equipment.

Caution: Risk of Electric Shock



7. Maintenance

In normal use, little maintenance is needed. As appropriate for service conditions, isolate electrical power, inspect the unit and remove any dust or other foreign material present. Periodically check all connections for freedom from corrosion and screw tightness, particularly if vibration is present.

The front of the case should be wiped with a dry cloth only. Use minimal pressure, especially over the viewing window area. If necessary wipe the rear case with a dry cloth. If a cleaning agent is necessary, isopropyl alcohol is the only recommended agent and should be used sparingly. Water should not be used. If the rear case exterior or terminals should be contaminated accidentally with water, the unit must be returned to Autometers Systems Ltd for inspection and testing.

8. Installation

The meter is designed to be fitted on a DIN rail in a suitable enclosure. The unit is intended for use in a reasonably stable ambient temperature within the range -25°C to +55°C. Do not fit the meter where there is excessive vibration or in excessive direct sunlight.

Please note terminal covers should be fitted and sealed.

See connection diagrams page 16.

8.1 Safety

The unit is designed in accordance with IEC 61010-1:2010 – Permanently connected use, Normal condition. Installation category III, pollution degree 2, basic insulation for rated voltage.

9. Electrician.

The MA-10 DIN rail meter should only be installed by a fully qualified electrician who has knowledge of electricity meters connected with current transformers.

It is the installer who is fully responsible for the safe installation of this meter. It must be installed to meet the current electrical regulations concerning installation of electricity meters.

IO. EMC Installation Requirements

Whilst this unit complies with all relevant EU EMC (electro-magnetic compatibility) regulations, any additional precautions necessary to provide proper operation of this and adjacent equipment will be installation dependent and so the following can only be general guidance: Avoid routing wiring to this unit alongside cables and products that are, or could be, a source of interference.

The auxiliary supply to the unit should not be subject to excessive interference. In some cases, a supply line filter may be required.

To protect the product against incorrect operation or permanent damage, surge transients must be controlled. It is good EMC practice to suppress transients and surges at the source. The unit has been designed to automatically recover from typical transients; however in extreme circumstances it may be necessary to temporarily disconnect the auxiliary supply for a period of greater than 10 seconds to restore correct operation.

Screened communication leads are recommended and may be required. These and other connecting leads may require the fitting of RF suppression components, such as ferrite absorbers, line filters etc., if RF fields cause problems.

It is good practice to install sensitive electronic instruments that are performing critical functions in EMC enclosures that protect against electrical interference causing a disturbance in function.

II. Wiring Diagrams

11.1 Voltage Connections

3 phase 4 wires

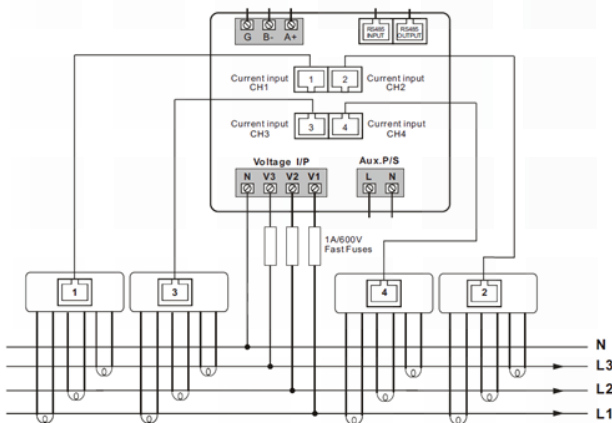

3 phase 3 wires

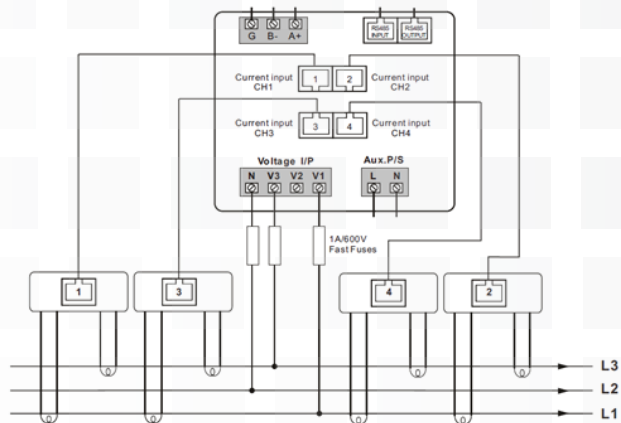

Single phase 2 wires

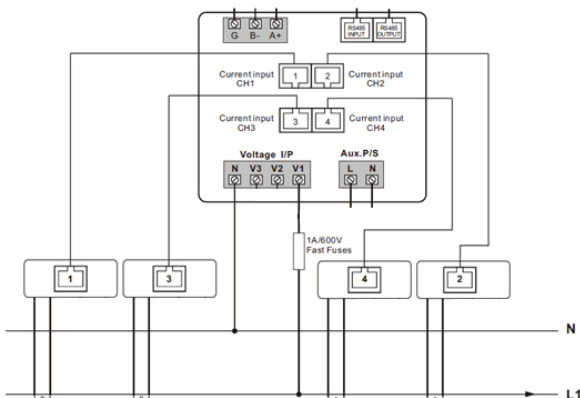

Single phase 3 wires

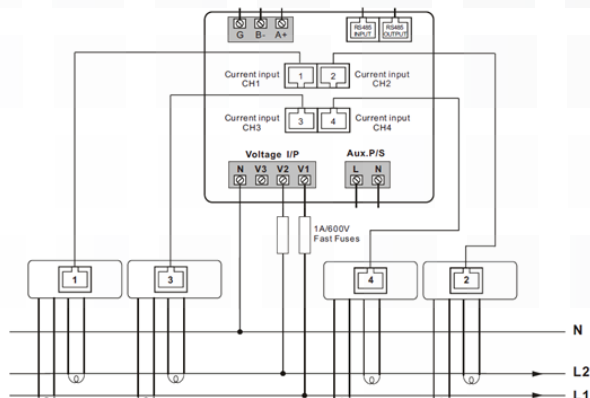

12. Autometers Universal Gateway (AUG) with the New MA-IO meter

RS 485 Modbus Communication to enable full data retrieval of kWh for Graphic analysis and Billing

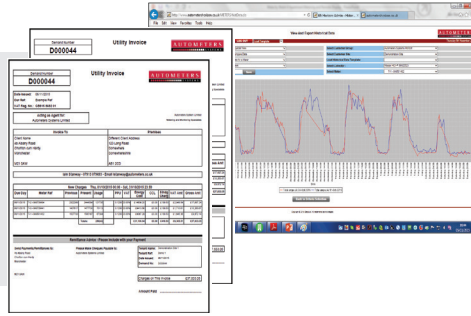

The AUG is a surface mounted GPRS enabled data collection device capable of storing information from up to 350 meters via 3 separate Lans

2 x Modbus – up to 127 meters on 1000 metres of Belden 9841 cable.

1 x M-bus – up to 100 devices on 1000 metres of Belcom 410P1824 cable.

The AUG is powered from either the HS-PS7 or PS13

Versatile Modbus connection

Meters can be connected using Easy-wire cables; hard wired using Belden cable; or a mix of the two.

TO NEXT METER



12.1 Easy-wire Modbus Connection

MODBUS IN

MODBUS OUT TO NEXT METER

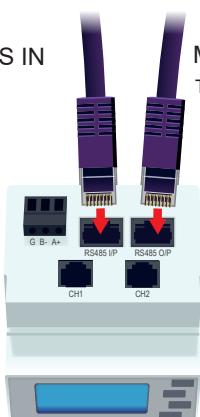

12.2 Hard Wired Modbus Setup

MODBUS IN MODBUS OUT

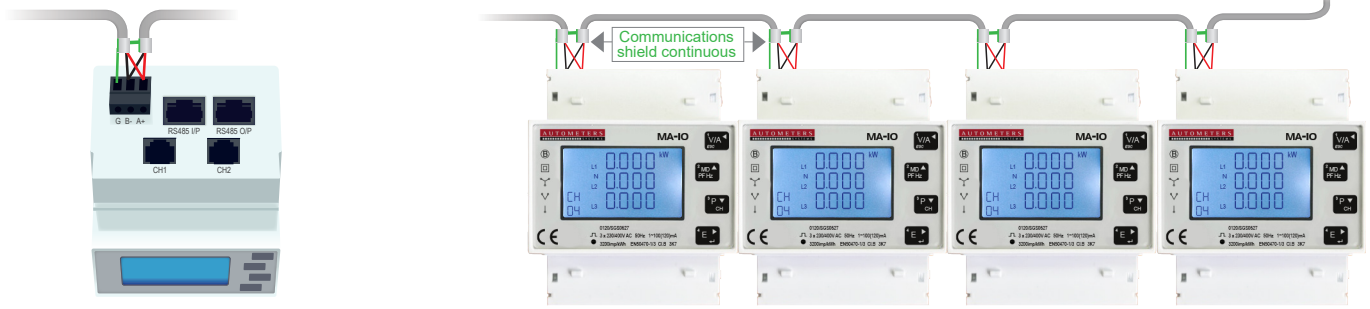

12.3 Hybrid Wiring Modbus Setup

MODBUS IN MODBUS OUT



13. Metal Enclosures for the MA-IO meter

Autometers manufacture a number of metal enclosures compatible with the full range of meters it supplies.

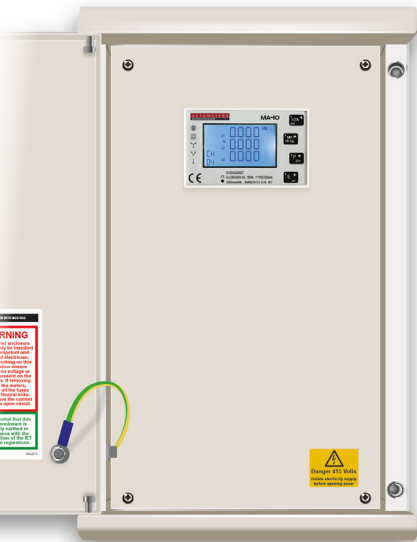

ME-1

The new ME-1 is the latest design for the range of electricity meters.

The enclosure consists of a fuse and shorting terminal arrangement, pre-wired to the meter inside the enclosure.

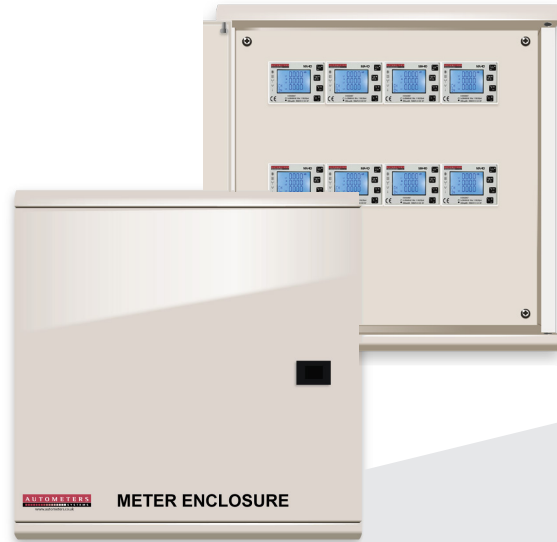

ME-32

The ME-32 enclosure can accommodate up to 16 meters.

Autometers Systems Ltd.
Unit 15c Raleigh Hall Industrial Estate, Eccleshall
Stafford ST21 6JL

Email: sales@autometers.co.uk
Phone: 00(44) 0161 861 9056
www.autometers.co.uk

Product development is continuous and Autometers Systems Limited reserves the right to make alterations and manufacture without notice. Products as delivered may therefore differ from the descriptions and illustrations in this publication

Ref. MA-10.140923

